

SCIENCE OF GYMNASTICS JOURNAL

vol. 3, num. 3, year 2011



Science of Gymnastics Journal (ScGYM®)

Science of Gymnastics Journal (ScGYM®) is an international journal that provide a wide range of scientific information specific to gymnastics. The journal is publishing both empirical and theoretical contributions related to gymnastics from the natural, social and human sciences. It is aimed at enhancing gymnastics knowledge (theoretical and practical) based on research and scientific methodology. We welcome articles concerned with performance analysis, judges' analysis, biomechanical analysis of gymnastics elements, medical analysis in gymnastics, pedagogical analysis related to gymnastics, biographies of important gymnastics personalities and other historical analysis, social aspects of gymnastics, motor learning and motor control in gymnastics, methodology of learning gymnastics elements, etc. Manuscripts based on quality research and comprehensive research reviews will also be considered for publication. The journal welcomes papers from all types of research paradigms.

Editor-in-Chief Ivan Čuk, Slovenia

Responsible Editor Maja Bučar Pajek, Slovenia

Editorial and Scientific Board

Mikko Pehkonen, Finland
Nikolaj Georgievic Suchilin, Russia
William Sands, USA
Kamenka Živčić Marković, Croatia
Ignacio Grande Rodríguez, Spain
Warwick Forbes, Australia
David McMinn, Scotland, UK
Almir Atiković, Bosnia and Herzegovina
José Ferreirinha, Portugal
Istvan Karacsóny, Hungary
Marco Antonio Bortoleto, Brazil
Hardy Fink, FIG Academy, Canada
Keith Russell, FIG Scientific Commission, Canada

Science of Gymnastics Journal is indexed in

EBSCOhost SPORTDiscus, COBISS (IZUM), SIRC (Canada), OPEN. J-GATE, GET CITED, ELECTRONIC JOURNALS INDEX, SCIRUS, NEW JOUR, GOOGLE SCHOLAR and INDEX COPERNICUS. ScGYM® (ISSN 1855-7171) is an international online journal published three times a year (February, June, October). ® Department of Gymnastics, Faculty of Sport, University of Ljubljana. All rights reserved. This journal and the individual contributions contained in it are protected under Copyright and Related Rights Act of the Republic of Slovenia.

Front page design: Sandi Radovan, Slovenia. In this issue Kristi Skebo (Canada) helped as a proof reader.

Editorial Office Address

Science of Gymnastics Journal
Faculty of Sport, Department of Gymnastics
Gortanova 22, SI-1000 Ljubljana, Slovenia
Telephone: +386 (0)1 520 7765
Fax: +386 (0)1 520 7750
E-mail: scgym@fsp.uni-lj.si
Home page: <http://www.scienceofgymnastics.com>

Science of Gymnastics Journal is supported by Foundation for financing sport organisations in Slovenia, Slovenian Book Agency and International Gymnastics Federation.



CONTENTS

Bruno Grandi	130 YEARS OF FIG, LETTER FROM FIG PRESIDENT	3
Ivan Čuk	EDITORIAL	5
Thomas Heinen Damian Jeraj Pia M. Vinken Katharina Knieps Konstantinos Velentzas Hedi Richter	WHAT IT TAKES TO DO DOUBLE JAEGER ON THE HIGH BAR?	7
Stefan Brehmer Falk Naundorf	AGE-RELATED DEVELOPMENT OF RUN-UP VELOCITY ON VAULT	19
Ivan Čuk Samo Penič A UHY^Gi dY^ Dejan Križaj	TOWARDS A SMART SPRINGBOARD (CASE STUDY)	29
William A. Sands Jeni R. McNeal Monèm Jemni Gabiella Penitente	THINKING SENSIBLY ABOUT INJURY PREVENTION AND SAFETY	43
Luisa Amaral Albrecht Claessens Jose Ferreirinha Paulo Santos	ULNAR VARIANCE AND ITS RELATED FACTORS IN GYMNASTICS: A REVIEW	59
Almir Atiković Nusret Smajlović	RELATION BETWEEN VAULT DIFFICULTY AND BIOMECHANICAL PARAMETERS IN MEN'S ARTISTIC GYMNASTICS	91
	SLOVENSKI IZVLEČKI / SLOVENE ABSTRACTS	106

130 YEARS OF FIG

LETTER FROM FIG PRESIDENT PROF. BRUNO GRANDI

Dear Friends of Gymnastics,

On the 23rd of July, 2011, the international gymnastics community has celebrated the 130th anniversary of the FIG creation. It all started in 1881, in Liege, Belgium.

The founder was a humanist, a visionary man, whose ideal was to bring people together around solidarity, tolerance and well-being, around the gymnastics principles. This man, Nicolas Cupérus, dreamed of gymnastics for all, men or women, from all backgrounds or generations; he knew being active was the only way to long term well-being, and that without well-being no culture or personal development would be possible. Indeed dear friends, health experts will confirm that while your car wears out with mileage, your body wears out and ages prematurely with inactivity.

Today, 130 years later, Cupérus' vision is more than ever appropriate. Physical activity and gymnastics are the cure and answer to many 21st century illnesses: idleness, obesity, unhappiness. All societies and age groups are affected and the effects extend not only to the individuals' performances but also to the health care system reaching huge deficit level.

The FIG global Gymnaestrada which was held in July in the Olympic Capital Lausanne, is a real solution to this malaise. Our 20.000 gymnasts gave us a brilliant answer with their enthusiasm, they delighted us with the quality of their routines, and they cheered us up with the beautiful lesson of life they displayed in Lausanne. I paid tribute to them all.

My dear friends, gymnastics and the FIG have come a long way together. Established in 1881, part of the Olympic movement since day one, our Federation is one of the oldest world sporting associations. In the early days of the FIG, Pierre de Coubertin and our founder Nicolas Cupérus could have crossed path. The former had the distinguished career we know and led the revival of the Olympic Games. The latter shared the same sporting ideal for the purpose of education and health.

There was a difference though! An important one. Coubertin spoke of competitions. Cupérus didn't value individual performance! He valued a sport for all abilities, for all levels, for everyone. The father of the gymnastics community wanted to create a universal movement, gathered around a vision of well-being, physical activity, body language, for all people and all ages. The Spirit of the World Gymnaestrada, gymnastics for all, was born in 1881 from the FIG founder's original quest. Cupérus had to abandon his project and bow down to those in favour of a competitive gymnastics. He did win posthumously when in 1953 Johannes Heinrich François Sommer, one of his loyal successors, organised the first World Gymnaestrada in Rotterdam.

Today, Gymnastics is one of the most important sports of the Olympic programme. Thanks to the artistic disciplines, we have a tremendous TV coverage the world over. But this success is not for ever. We must pay attention to the future of our sport.

I recently invited all the technicians to attend a Symposium dedicated to the Code of Points of all of our 6 competitive disciplines, in order to evaluate the positioning and the potential development of our sport. The more seasoned among us remember back to the first Code. A twelve-page opus crafted by Gander, Lapalu and Hentges, it gave structure to Men's Artistic Gymnastics and mapped out judging in three distinct categories: difficulty, combination and execution. That was back in 1949.

Today, the Code reaches out to cover all FIG disciplines; it governs everything, infiltrating gymnastics like a metastasis that spreads and traps the sport in its deadly net. Originally created to serve the

development of our sport, the Code has mutated into a time bomb that we are wholly unable to contain. Worse, it is a pitfall to judges and gymnasts alike, and creates situations that are often impossible to navigate. Remember Athens!

The time has come for us, the technicians, judges and leaders in sport, to gather round a single table and revisit the Code; to re-equip our discipline with the structure and spirit originally inherent to it. This is the endgame of the FIG Symposiums for Rhythmic Gymnastics in Zurich (SUI) at the end of April, for Artistic and Trampoline in mid-June and for Aerobic and Acrobatic in September. Simplify the Codes; we all agree on this point. Keep in mind the essence of Roman law, the first legal system in the history of Man and which is still active today. According to our predecessors, excessive detail is what dilutes and suffocates justice. Too many laws annihilate law itself!

Starting in 2005, we took successful steps toward standardising our Codes; a commendable action, to be sure, but a far cry from being enough. What we need is complete and unequivocal reform if we hope to have a Code that serves to further develop our sport. We must simplify, not complicate. What is the essential reason for the Code? What is it made to do? What is the meaning of its existence? The answer is found in history, whose most basic message is that in order to move forward into the future, one often needs to take a brief look into the past.

At the 1948 Olympic Games in London, judging in gymnastics was scandalous! Judges were using criteria to evaluate exercises specific only to their own countries. It was a free for all. Such chaos! A Code was then created to clarify and classify criteria to maintain a standardised approach to judging. Unity was finally re-established. A mere twelve pages in 1949 compared to hundreds today, not counting the thousands of symbols that go with them! How can a judge effectively react, evaluate and decide in mere seconds and under the pressure that goes hand in hand with, say, an Olympic Final? Impossible; it is beyond human capacity.

We need a Code, a point of reference, which will bring structure to the evaluations brought by our judges and allow us to employ the Fairbrother system. Only by doing this will we be able to avoid situations such as were experienced in Athens and London. We have the tools, IRCOS for one, which can aid in attributing an accurate technical score if used properly. But we must accept the fact that the Artistic score is largely a product of a more subjective, and certainly human, evaluation. That is the variable in our equation; fallible but not unjust. And if we are to lose ourselves in the nimbus of objectivity, we have reference judges in the wings to set our course straight.

Thank you all for your attention.

EDITORIAL

Dear friends,

International Gymnastics Federation celebrates 130 years since it has been established. Respectable anniversary, no other sport federation has it. In many ways FIG showed the way to sport and science, so we asked FIG president Prof. Bruno Grandi to write some past, present and future aims of gymnastics family.

The last year issues of Journal were visited by more than 16000 visitors, what gives us a true compliment for our endeavor. By the New Year 2012 we will establish ScholarOne Manuscript Software for easier work with articles for authors, reviewers and publishers. We were included into Index Copernicus, we are waiting to be included into Proquest Physical Education Index, and in 2013 we will be evaluated by Thomson Reuters to become part of Science Citation Index. In the mean time we need to continue with good articles (you are welcome to contribute your knowledge to the gymnastics world) which will be cited also in other scientific journals.

October issue of the Journal starts with the design of double Jaeger on high bar. Thomas Heinen, Damian Jeraj, Pia Vinken, Katharina Knieps, Konstantinos Velentzas and Hedi Richter performed a huge series of calculations (on the basis of known results from Jaeger, Gaylord and Pegan saltos). They found out Double Jaeger is possible to perform (actually by some evidence Valerij Ljukind did it in training sessions) but it has certain limitations. What German Austrian team calculated we will wait to see in vivo at the competition.

The second article is by German authors Stefan Brehmer and Falk Naundorf. They analyzed runway speed characteristics of the young gymnasts. There is an increase in the velocity up to the end of men's junior gymnastics age, followed by stagnation in senior age. The speed increase in pubescence and adolescence do not differ. Therefore coordinative and conditional factors determined the development of run-up velocity equally.

The third article comes from Slovenia. Ivan Čuk, Samo Penić. 'O cvgl' "Uvr gl "and "Dejan" Križaj "made a new technology (with accelerometer) for evaluating action on springboard. Results gathered from the new technology are similar to those obtained by other technologies. New technology can be used for training and scientific purposes.

The fourth article is from combined team from USA and UK: Wiliam A. Sands, Jeni R. McNeal, Monèm Jemni, Gabriella Penitente and deals with the safety in gymnastics. Five questions are proposed as a model for injury prevention and safety. Do not forget – only healthy gymnast can fulfill his champion dream.

The fifth article deals with gymnast's morphology. Portuguese authors Luísa Amaral, José Ferreirinha Paulo Santos with Belgium expert Albrecht Claessens write about the incidence of positive, neutral and negative ulnar variance between gymnasts and the general population (both immature and mature), seeking to identify possible wrist injury risk factors, which usually influence the gymnasts' health and performance.

The sixth article is from Bosnia and Herzegovina, authors Almir Atiković and Nusret Smajlović did interesting analyze of the FIG vault difficulty values. Since it has been in May FIG symposium on Code of Points their work can help towards better design of difficulty values.

I wish you pleasant reading and a lot of inspiration,

Ivan Čuk
Editor-in-Chief

WHAT IT TAKES TO DO THE DOUBLE JAEGER ON THE HIGH BAR?

Thomas Heinen¹, Damian Jeraj¹, Pia M. Vinken², Katharina Knieps³,

Konstantinos Velentzas¹ & Hedi Richter¹

¹ German Sport University Cologne, Germany

² Leibniz University, Hannover, Germany

³ University of Vienna, Austria

Original research article

Abstract

Nowadays, the Jaeger (forward salto behind the bar to regrasp) is seen as a basic flight element, already taught early in a gymnast's career. Acknowledging, that gymnasts have made advances in the development of new techniques on the high bar, the aim of the present study was to show that the double Jaeger is actually possible to be performed, and to specify the mechanical conditions one athlete must provide to have the competence to perform. A computer simulation model was used to investigate the mechanical conditions of different variants of the double Jaeger (tucked and piked). Input to the model comprised a national level gymnast's segmental inertial parameters, and the gymnast's performance in terms of the calculated and smoothed angle-time histories of Jaeger and Gaylord performances. Initial conditions consisted of the gymnast's vertical and horizontal release velocities of the center of mass, the angular velocity about the transverse axis, and the joint angles at release. Model output comprised the resulting motion of the gymnast. A systematical variation of the skill's parameter space led to a total of $n = 940896$ simulations. From these, 3.26% were successful for the double tucked Jaeger, and 2.50% were successful for the piked variant. Due to the simulation it can be concluded, that the double Jaeger is a hypothetically feasible skill for gymnasts who can produce a defined angular momentum together with a defined time of flight.

Keywords: *simulation, motor control, techniques, gymnastics.*

INTRODUCTION

In the last decades, Olympic gymnasts have made advances in the development of new techniques and original maneuvers on the high bar (Brüggemann, 1994; Prassas, Kwon & Sands, 2006; Čuk, Atiković & Tabaković, 2009). For instance, gymnasts have recently performed the Tkatchev Salto and the Jaeger in layout posture with double twist on the high bar. Skills on the high bar have long been subject to biomechanical analyses, and research has mainly focused on dismounts, flight elements and the mechanics of the associated giant swings

(Brüggemann, Cheetham, Alp & Arampatzis, 1994; Prassas et al., 2006). Techniques of simulating and modeling aerial performance have provided insights in the underlying processes of current performances and movement techniques, which are both important for coaches and researchers (Hiley, Yeadon & Buxton, 2007; Yeadon, 1997). Furthermore, "new" techniques and elements have been demonstrated by using computer simulation (e.g. Hiley, & Yeadon, 2005; Nissinen, Preiss & Brüggemann, 1985). It was for

instance recently shown, that the Tkatchev Salto is a biomechanically plausible maneuver for those gymnasts who are able to perform the straight Tkatchev with a defined time of flight (Čuk et al., 2009). From this point of view, the aim of the current study was to analyze the mechanical conditions under which a “new” element, the double Jaeger, would be possible to perform. In order to approach this aim, a computer simulation model was used.

Nowadays, the single Jaeger is seen as a rather basic flight element, already taught

early in a gymnast’s career (Arkaev & Suchilin, 2004). In its original execution, the gymnast releases the bar from an undergrip, performs a forward salto behind the bar in straddled posture, and regrips the bar after finishing the salto (see Figure 1a). The Jaeger can be divided into the following four phases: (1) preparation (2) release, (3) flight and (4) regrip. (cf., Holvoet, Lacouture & Duboy, 2002; Čuk, 1995; Fink, 1988).

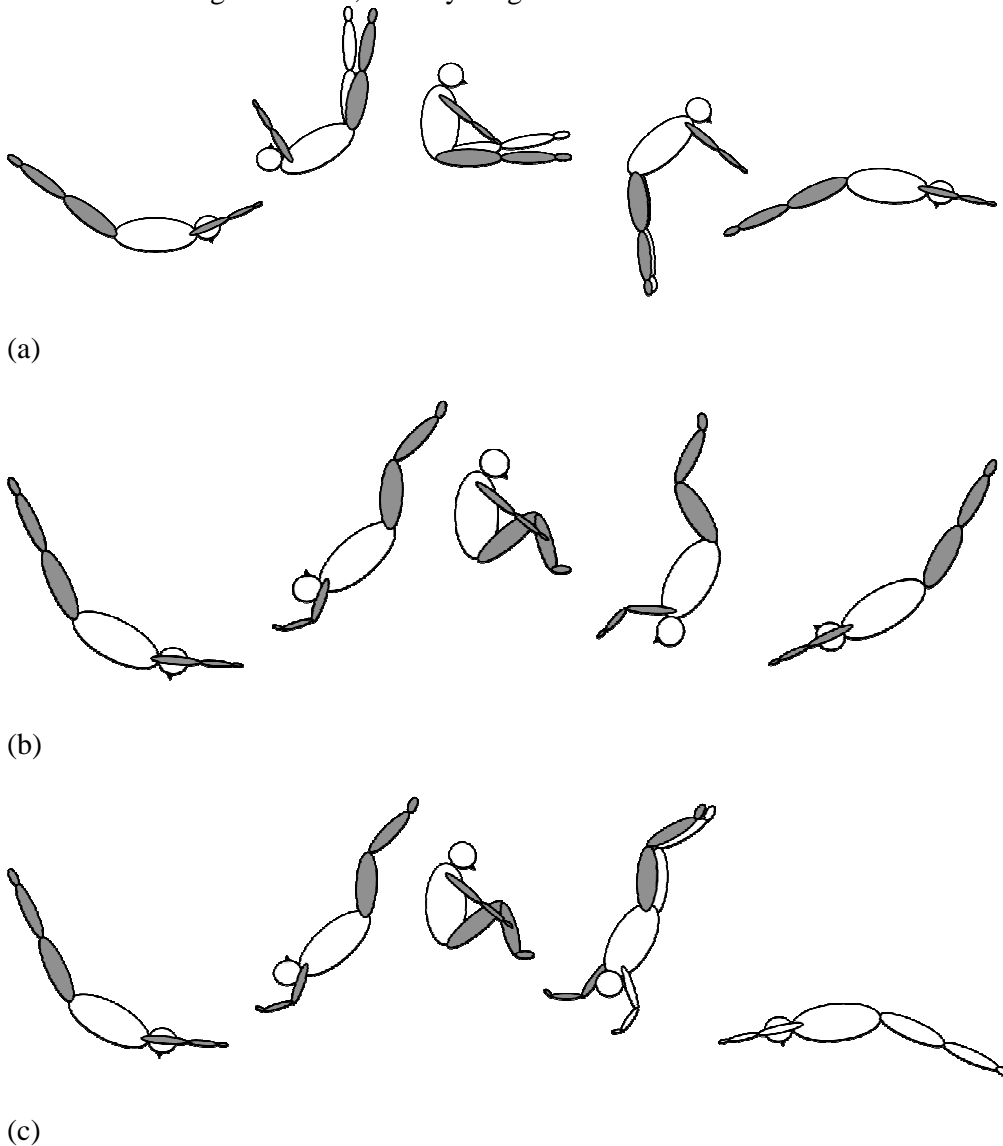

Figure 1. *Picture sequences of the straddled Jaeger salto (a), the tucked Gaylord salto (b) and the tucked Pegan salto (c). Note, that the right arm and the right leg is marked in grey.*

The gymnast has to generate sufficient angular momentum during the preparation phase towards the release, and to obtain adequate height during the flight phase in order to have enough time in the air to complete the intended salto rotation. The flight curve (determined by the velocity of the center of mass at release) should guarantee a safe regrasp of the bar and the continuation of the routine (Brüggemann, Cheetham, Alp & Arampatzis, 1994). Once, the gymnast has released the bar, the movement options are constrained due to the fact, that the release velocity predetermines the flight path, and the magnitude and direction of the angular momentum with respect to the center of mass cannot be changed (Brüggemann, 1994; Raab, de Oliveira & Heinen, 2009). The gymnast can only change his or her moment of inertia during the flight phase by changing body posture in order to increase or decrease his angular velocity or to initiate or to end twists (Brüggemann, 1994).

Brüggemann et al. (1994) analyzed 70 dismounts and release-regrasp skills on the high bar during the men's high bar competition at the 1992 Barcelona Olympic games. With regard to the Jaeger, the authors found a vertical release velocity of the center of mass of $3.84 \pm 0.25 \text{ m s}^{-1}$, and an angular momentum about the transverse axis of $31.8 \pm 10.5 \text{ N m s}$ (with respect to an "average" gymnast of 1.60 m body height and 62 kg body weight). Additionally, Gervais and Tally (1993) analyzed the performances of 15 male gymnasts during the 89 Canadian National Gymnastics Championships. The authors found that the trajectory of the center of mass in the Jaeger was near vertical ($87 \pm 4^\circ$), resulting in a predominantly vertical velocity at release with an estimated airborne time of $0.87 \pm 0.08 \text{ s}$. The height of the center of mass during flight was $0.83 \pm 0.15 \text{ m}$ above release. The hip angle showed negative values of $-36 \pm 8^\circ$, and the center of mass was $0.02 \pm 0.80 \text{ m}$ relative to the bar at release. Gymnasts regrasped the bar slightly below the horizontal axis (center of mass: $-0.15 \pm 0.09 \text{ m}$).

Meanwhile another point of interest was the question of feasibility of a "new" element: the double Jaeger. According to some anecdotic evidence, the former top level gymnast Valeri Liukin already practiced the double Jaeger in tucked body posture in training more than 20 years ago, but he never performed the skill in competition (personal correspondence with Hardy Fink and Edouard Iarov). Nissinen et al. (1985) used a two-dimensional computer model to simulate human airborne movement on the horizontal bar to investigate this skill. The authors were the first to simulate a double Jaeger in tucked body posture and stated, "According to our simulation the forward double somersault tucked would be a very difficult movement to perform. The initial values had to be unrealistically modified in order to make this movement at all possible" (p. 375). Apart from the fact that the authors did not present any data to support their conclusions, one has to take into account that the analyses were conducted more than 20 years ago. Not only the gymnasts but also the equipment made significant improvement during the last decades, making more dynamic elements, like the Gaylord or Pegan, possible (Prassas et al., 2006). Moreover, computer simulation techniques have also improved, leading to more detailed and more precise simulations of complex skills (Yeadon & King, 2008). Therefore, the present study is a first attempt to investigate the mechanical conditions under which a double Jaeger would be possible to be performed.

Gymnasts are, however, able to perform release-regrasp skills with more than one salto rotation on the high bar, such as the Gaylord salto (one and a half salto over the high bar to regrasp, see Figure 1b) or the Pegan salto (Gaylord with additional half twist prior to regrasp; see Figure 1c). Čuk (1995) as well as Brüggemann et al. (1994) analyzed Gaylord and Pegan saltos on the high bar. Brüggemann et al. (1994) found, that athletes generated vertical release velocities of $4.22 \pm 0.33 \text{ m s}^{-1}$ in the Gaylord with angular momentum about the

transverse axis of about $39.2 \pm 6.3 \text{ N m s}$ (with respect to an “average” gymnast of 1.60 m body height and 62 kg body weight). Čuk (1995) found the highest vertical release velocity for a Pegan ($v = 5.31 \text{ m s}^{-1}$). The author reported a time of flight of 0.80 s for the Gaylord and 0.92 s for a Pegan salto.

From the current research it can be concluded that gymnasts are able to generate approximately 12% higher angular momentum, and a 16% higher vertical release velocity when performing a Gaylord or a Pegan salto as compared to a single Jaeger salto (cf., Brüggemann et al., 1994). From this it was hypothesized, that the aforementioned differences might account for the realization of a “new” element, the double Jaeger, in which athletes potentially need to generate larger amounts of linear momentum, angular momentum, or both until they release the bar. To test this hypothesis, the parameter-space (number and distribution of movement options) of the double Jaeger was explored by systematically varying the motion of a single Jaeger in a computer simulation model. In particular, the mechanical conditions were investigated, that would result in a regrip after a defined salto rotation angle.

METHODS

Data collection

The data were collected in collaboration with a national level male gymnast (23 yrs, 1.67 m, 70 kg) during training while he performed single layout Jaegers (7 trials) and tucked Gaylords (7 trials) from undergrip. The performances were videotaped with two Casio Exilim Pro EX F1 cameras, operating at 300 fps (spatial resolution: 512 x 384 pixels). The two cameras were placed approximately 15 meters away from the high bar, and above the stands with an angle of 90° between the optical axes. The object field was calibrated with a 4 x 4 x 1 m calibration cube filmed before and after the performances. Two failed trials were excluded from the further

analysis, because the gymnast regripped 6 of the 7 Jaegers as well as 6 of the 7 Gaylords. Two independent national level coaches rated the 12 remaining trials with regard to their movement quality. They were asked to serialize the six performances of each skill and pick the best performance out of the six. Both coaches picked the third performance of the Jaeger and the fourth performance of the Gaylord. The gymnast's best performances were digitized using the Software WinAnalyze3D (Mikromak, 2008). The 3D coordinates of the body landmarks were reconstructed from the digitized data using the DLT technique (Shapiro, 1978). A digital filter (cut off frequency = 8 Hz) for data smoothing was applied and a mean temporal error of $\pm 0.0033 \text{ s}$, and a mean spatial error of $\pm 0.007 \text{ m}$ were calculated from the data. The corresponding joint angle histories were calculated from the 3D coordinates of the segment endpoints.

Simulation Model

A computer simulation model for skills in gymnastics was built with the help of the computer software MSC.visualNastran 4D version 7.1 build 81 (copyright 1996-2003 MSC.Software). The model consisted of 16 segments representing two feet, two shanks, two thighs, the hip and lower trunk, the middle trunk, the upper trunk, two upper arms, two forearms, two hands, and the head of the gymnast. 15 joints connected the segments. The model was customized to an elite gymnast through the determination of subject-specific inertial parameters (cf., Yeadon, 1990a; Yeadon & Morlock, 1989). Input to the model comprised the segmental inertial parameters, the gymnast's performance in terms of the calculated and smoothed angle-time histories. Initial conditions consisted of the gymnast's vertical and horizontal release velocities of the center of mass, the angular velocity about the transverse axis, and the joint angles at release. The joint angles at release that were different from zero are shown in Figure 2a. These were the shoulder bar

angle ($\alpha_{shbar} = -20^\circ$), the shoulder angle ($\alpha_{sh} = -15^\circ$), the angle between upper and middle trunk ($\alpha_{th3} = -5^\circ$), the angle between middle

and lower trunk ($\alpha_{th1} = -10^\circ$), and the angle between the lower trunk/hips and the thighs ($\alpha_{hip} = -40^\circ$).

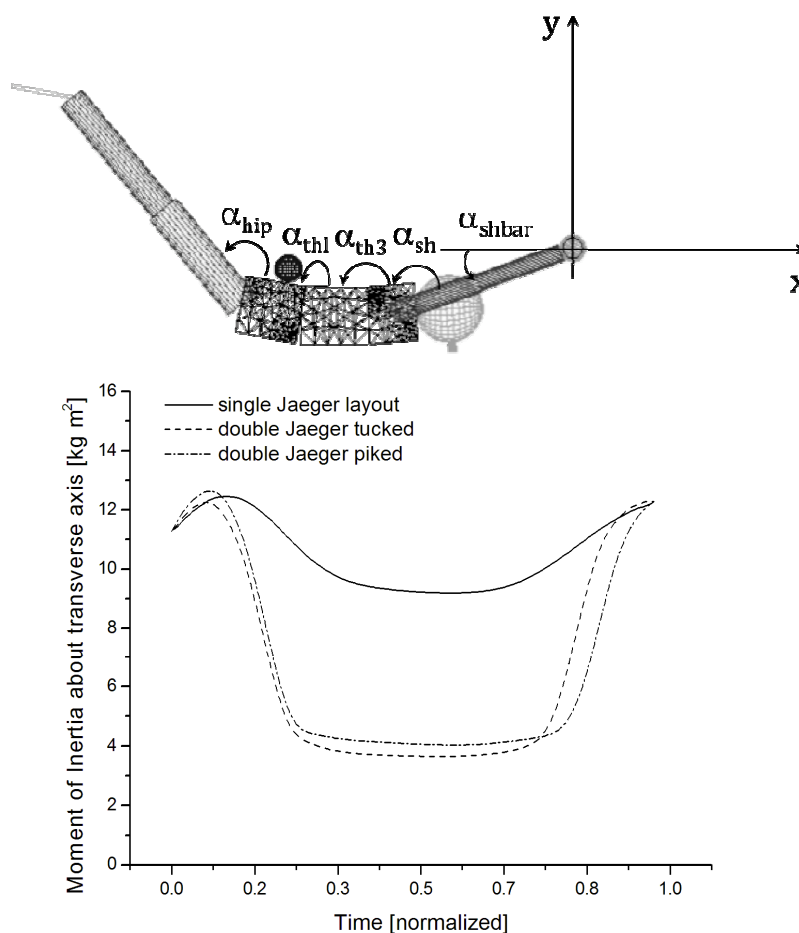

Figure 2. (a) Graphical representation of the simulation model and definition of the global coordinate system as well as the body angles (extension/flexion) whose initial conditions were different from zero. The black circle represents the position of the model's center of mass. (b) Time-normalized course of moment of inertia about the transverse axis in different Jaeger salto simulations.

The Kutta-Merson algorithm was used with a frame rate of 300 frames per seconds and a variable integration step size of 0.00167 seconds to solve the model's motion. Output from the model comprised the resulting motion of the gymnast. A three-dimensional computer graphics model of the human body was used to illustrate the model output after the motion was solved (see Figure 2a and Figure 3).

Procedure

The procedure in the present study consisted of two steps. In the *first step* the Jaeger in layout position was simulated based on the performances of the national level gymnast. Therefore the gymnast's angle-time histories were integrated together with the gymnast's vertical and horizontal velocity at release, as well as the angular velocity about the transverse axis at release, in the present model.

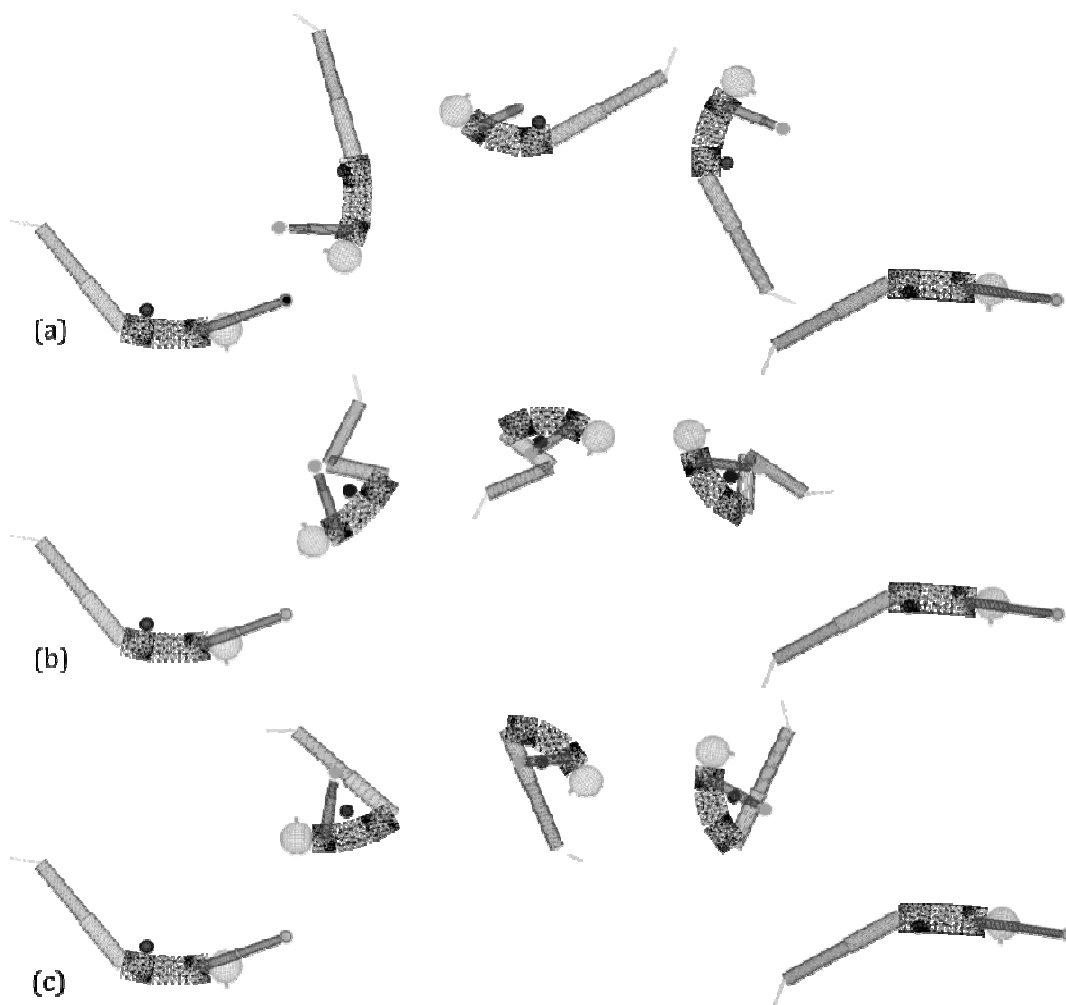

Figure 3. Picture sequences of the optimized simulation outputs for the single Jaeger in layout posture (a), the double Jaeger in tucked posture (b), and the double Jaeger in piked body posture (c). **Note:** The single Jaeger (a) was modeled from the gymnast's performance. The simulations of the double Jaeger in tucked body position (b), and piked body position (c) used the same release angles as the original simulation, and were optimized to such an extent that the time of flight and the body configuration at regrasp matched the original simulation. The black circle represents the model's center of mass.

In the *second step*, the amount of movement options was estimated from the resulting motion of the model for each simulated variant of the Jaeger salto. In particular, the points of interest were the number and distribution of possible movement options, resulting in a regrasp after a defined salto angle. The movement options comprised different values of angular momentum at release, and different time-courses of the moment of inertia about the transverse axis in a given time of flight. The salto angle was therefore defined by the line joining the middle of the shoulders to

the middle of the knees (Brüggemann et al., 1994; Yeadon, 1990b). The salto angle was calculated for the different simulated variants of the Jaeger. The time-course of the moment of inertia was constrained to biomechanically plausible time-courses. The time-courses were derived following the results of analyses of the Gaylord performance of the expert gymnast together with results from the current literature (Brüggemann et al., 1994; Čuk, 1995). The moment of inertia about the transverse axis at release and regrasp, as well as the body orientation and joint angles were matched

with the values of the simulated layout Jaeger. This was done to optimize the model's performance, assuming that a gymnast performing the Jaeger in this way would be able to continue his routine after regrasp.

Batch simulations were run, varying the angular momentum at release systematically about $\pm 10 \text{ N m s}$ (cf., Brüggemann et al., 1994; Gervais & Tally, 1993), the moment of inertia about $\pm 0.5 \text{ kg m}^2$ (Knoll, 1999; Kerwin, Yeadon & Lee, 1990) and its significant events in its time-course about $\pm 40 \text{ ms}$ (Latash, 2008). One simulation cycle was marked as successful if the model produced a salto rotation angle between $\pm 5^\circ$ of the original rotation angle. The batch simulations were carried out in 10 steps for each combination of all mentioned parameters.

RESULTS

Original performance of the Jaeger

Integrating the gymnast's angle-time histories together with the gymnast's vertical and horizontal velocity at release, as well as the angular velocity about the transverse axis at release in the present model, led to a successful performance of the single Jaeger Salto in layout position (Figure 3a). The salto angle, the time of flight, and the angular momentum were calculated from the original performance of the single Jaeger salto as well as from the Jaeger performance of the simulation model. The time courses of both angles, the times of flight and the angular momentum were compared in order to evaluate the simulation model. The simulated salto rotation angle matched the recorded angle within 1.7° RMS difference (cf., Hiley & Yeadon, 2007) The time of flight matched the original performance within 0.0033 seconds, and the angular momentum about the transverse axis matched the actual performance within 0.7%.

Z-tests on the corresponding values were calculated in order to compare the model's kinematic parameters with published data of Gervais and Tally (1993)

and Brüggemann et al. (1994). The time of flight for the single Jaeger salto in layout position was 0.96 seconds ($z = 1.10$, $p = .14$, cf., Gervais & Tally, 1993). The model's center of mass was 0.07 m below the bar at release ($z = -0.11$, $p = .91$, cf., Gervais & Tally, 1993). The model achieved a height of flight of 1.10 m ($z = 1.80$, $p = .07$, cf., Gervais & Tally, 1993) and regrasped the bar having its center of mass 0.05 m above the bar ($z = 2.22$, $p = .03$, cf., Gervais & Tally, 1993). The model's angular momentum was normalized to a body weight of 62 kg and a body height of 1.60 m in order to permit comparison with the results of Brüggemann et al. (1994). Therefore, the absolute values of the angular momentum were multiplied by a normalization factor k (Knoll, 1999; Kwon, 1996). The factor k was expressed as follows:

$$k = \frac{m_0}{m} \cdot \left(\frac{h_0}{h} \right)^2$$

m_0 represents the body weight (62 kg) and h_0 represents the height (1.60 m) characterizing an "average" gymnast (see Brüggemann et al., 1994). m and h represent the body weight and height of the participating gymnast in the present study. The normalized angular momentum about the transverse axis was 53 N m s. This value was not significantly different from previously published results ($z = 0.77$, $p = .44$, cf. Brüggemann et al., 1994). The salto rotation angle was $\gamma = 330.4^\circ$.

Simulated performance of the double Jaeger

The movement options were estimated from the resulting motion of the model for each simulated variant of the double Jaeger in tucked and piked body posture. In particular the points of interest were number and distribution of possible movement options, resulting in a regrasp after a defined salto rotation angle. Furthermore the focus lay in the maximal angular velocity about the transverse axis during the flight phase. Running batch simulations, varying the angular momentum at release, and the time course of the moment of inertia (absolute values and

significant events in its time-course) led to a total of $N = 940896$ simulation cycles. From these, $n = 30672$ (3.26 %) were found to be successful for the double Jaeger salto in tucked position (see Figure 3a), and $n = 23481$ (2.50 %) were found to be successful for the double Jaeger salto in piked position (see Figure 3b), leading to a regrasp after rotating $690.4^\circ \pm 5^\circ$. An optimized performance of the double Jaeger in tucked body position is shown in Figure 3b, and an optimized performance of the double Jaeger in piked body position is shown in Figure 3c to illustrate the resulting simulation output. The resulting motions were optimized to such an extent that the time of flight and the body configuration at regrasp matched the original simulation. The minimum moment of inertia was reached after approximately 28 % of the movement time from release to regrasp in the tucked variant, and after approximately 26 % of the movement time in the piked variant.

An inspection of the distribution of movement options for the double Jaeger in tucked position revealed, that there existed a clear trend towards achieving a minimal critical angular momentum about the transverse axis to cover the full range of movement options in different flight durations. The number of movement options increased quadratic as a function of angular momentum about the transverse axis ($R^2 = .98$, Cohen's $f^2 = 49.0$, $p < .01$). The minimum value was 59 N m s, such that the model covered the full functional range of movement options. This value was not significantly different from the values, that Brüggemann et al. (1994) found for the Jaeger salto, after rescaling them to the inertial characteristics of the participating national level gymnast ($z = 1.53$, $p = .06$). The values of the maximum angular velocity about the transverse axis ranged between 786° s^{-1} and $1024^\circ \text{ s}^{-1}$ with a mean value of $925 \pm 53^\circ \text{ s}^{-1}$.

An inspection of the distribution of movement options for the double Jaeger in piked position revealed, that there also existed a clear trend towards achieving a minimal critical angular momentum about

the transverse axis to cover the full range of movement options with respect to different flight durations. The number of movement options increased linear as a function of angular momentum about the transverse axis ($r = .97$, $p < .01$, Cohen's $f^2 = 15.7$). The minimal critical value was approximately 61 N m s, and assured, that the model covered the maximum functional range of movement options. This value was significantly higher than previously published values for the Jaeger salto ($z = 1.69$, $p = .04$; cf., Brüggemann et al., 1994) after controlling for body height and weight. However, there was no significant difference from published values for the Gaylord Salto ($z = 1.05$, $p = .14$). The values of the maximum angular velocity about the transverse axis ranged between 777° s^{-1} and 945° s^{-1} with a mean value of $884 \pm 43^\circ \text{ s}^{-1}$.

DISCUSSION

The aim of the present study was to find out if a “new” element, the double Jaeger, would be possible to be performed in general and to analyze the mechanical conditions under which this is the case. Therefore the parameter space (number of movement options) was explored in different variations of the skill. Given, that gymnasts are able to generate approximately 12% higher angular momentum and 16% higher vertical release velocities when comparing the Jaeger with a structural similar movement such as the Gaylord or the Pegan salto, it can be hypothesized, that these “mechanical resources” might account for the realization of a “new” element, the double Jaeger.

For the present study a simulation model for gymnastic skills was used based on the performance of Jaegers and Gaylords on the high bar of one national level gymnast. Concerning the results it can be stated, that the present model represented the performance of a single Jaeger in layout posture quite adequately (e.g., RMS difference = 1.7° between recorded and simulated salto angle). The results of the subsequent analyses revealed that the

double Jaeger in tucked or in piked body position can be realized with biomechanically plausible time courses of the moment of inertia about the transverse axis (derived from the analysis of a Gaylord salto) together with different combinations of angular momentum about the transverse axis and time of flight.

From the data it can be concluded, that the double Jaeger is possible in either tucked or piked body posture, because both skills could be realized in the full range of available movement options, assuring, that at least the gymnast could achieve a minimal critical value of angular momentum. When performing the tucked variant, a gymnast weighting 70 kg with a body height of 1.67 m should be able to generate an angular momentum of at least 59 N m s with a minimal time of flight of 930 ms, to cover the full range of movement options. For the piked variant, the same gymnast should be able to produce an angular momentum of at least 61 N m s with a minimal time of flight of 930 ms. In both variants, the minimum moment of inertia should be reached after approximately 26 - 28 % of the movement time from release to regrasp. Quite surprisingly, the minimal critical value was not significantly different from previously published values of either the Jaeger or the Gaylord salto (cf., Brüggemann et al., 1994; Nissinen et al., 1985) and therefore it can be concluded that – at least from a biomechanical point of view – the double Jaeger should be realizable by well-trained gymnasts.

In addition, it was found, that the highest angular velocities about the transverse axis occurred in the tucked variant of the double Jaeger ($v_{max} = 1024 \text{ }^\circ \text{ s}^{-1}$). Analyses of the performance of world's best athletes reveals, that they realize angular velocities about the transverse axis up to $1300 \text{ }^\circ \text{ s}^{-1}$ (Krug, 1997) with similar or even smaller moments of inertia about the transverse axis that was found for the simulation of the double Jaeger. From this it can be concluded, that trained athletes should be able to deal with angular velocities larger than $930 \text{ }^\circ \text{ s}^{-1}$ when

performing the double Jaeger in either tucked or piked body position (von Laßberg, Mühlbauer & Krug, 2003; Krug, 1997).

Despite its feasibility, there may be three arguments why the Jaeger Salto on the high bar is not performed that often in international competitions, and potentially, why the double Jaeger may not be attractive for gymnasts to learn as compared to other release-regrasp skills. First, the Jaeger salto is a forward salto during which the athlete "sees" the high bar relatively late prior to regrasp, and therefore has less time to adjust the regrasp based on visual information, as compared to other flight elements, like the Tkatshev (Gervais & Tally, 1993; Raab, de Oliveira & Heinen, 2009). Second, the athlete has to reverse the direction of his rotation when regrasping the bar, as compared to other flight elements, like the Kovacs Salto if he intends to perform a subsequent giant swing. This significantly constrains the movement options after regrasping the bar in terms of subsequent flight elements and in terms of the energy exchange between the gymnast and the high bar (Brüggemann et al., 1994). Furthermore, it may be not attractive for gymnasts to perform the Jaeger due to the current competition rules of the International Gymnastics Federation (FIG, 2009). In particular, the flight elements on high bar depend on precise execution, and irregularities in movement execution could lead to a fall off the apparatus, and/or to score deduction if the movement cannot be performed according to the officiating guidelines. That is why elite gymnasts may prefer a gymnastic routine, which is based on a low risk decision. Another aspect refers to the question how to integrate the double Jaeger into a gymnastic routine, so that there is enough energy to perform the skill on the one hand, and to make it possible for the gymnast to perform his following gymnastic routine without score deduction on the other hand.

Acknowledging that there are several limitations of the present study two specific aspects are discussed in the following: First, a simulation model was used to estimate the

mechanical conditions and functional range of movement options of the double Jaeger, but it was not evaluated if a real gymnast would be able to perform the double Jaeger on the high bar. Moreover officially it is not known that someone has tried to perform the double Jaeger so far in competition. Acknowledging, that gymnastic equipment as well as methodical progressions made significant enhancements in the last decades, it is likely, that nowadays practitioners may find strategies to develop methodical progression for the skill, and gymnasts will be able to realize the skill.

Second, the simulation model consisted of 16 segments (rigid bodies), and 15 joints. It was customized to an elite gymnast through the determination of subject-specific inertial parameters. The model did not comprise parameters related to the muscles, such as force-length or force-velocity relationships. Furthermore, the preparatory phase of the Jaeger was not part of the simulation model. However, one might be interested in how the actions of different muscles may account for different Jaeger performances and/or how differences in the preparatory phase may be related to differences in Jaeger performance. This would in turn lead to necessary developments of the simulation model, which could be part of subsequent studies.

Finally, It must be stated, that progressions or training programs with the ultimate aim of enabling athletes to perform the double Jaeger, should only be developed whilst ensuring the safety of the gymnast. Computer simulation techniques may help the coach to estimate if one specific gymnast would potentially be able to perform the double Jaeger, given that the athlete provides certain prerequisites such as mastering the Gaylord and the single Jaeger with a defined linear and angular momentum. Subsequent studies should first and foremost discuss the safety conditions and coaching approaches to close the gap between the findings of a prospectively feasible skill (competence dimension) and the question of transfer to real performance of the double Jaeger.

REFERENCES

- Arkaev, L. I., & Suchilin, N. G. (2004). *How to Create Champions. The Theory and Methodology of Training Top-Class Gymnasts*. Oxford: Meyer & Meyer Sport.
- Brüggemann, G.-P. (1994). Biomechanics of gymnastic techniques. *Sport Science Review*, 3(2), 79-120.
- Brüggemann, G.-P., Cheatham, P. J., Alp, Y., & Arampatzis, D. (1994). Approach to a biomechanical profile of dismounts and release-regrasp skills of the high bar. *Journal of Applied Biomechanics*, 10, 291-312.
- Čuk, I., Atiković, A., & Tabaković, M. (2009). Tkachev salto on high bar. *Science of Gymnastics Journal*, 1(1), 5-13.
- Čuk, I. (1995). Kolman and Pegan saltos on the high bar. In T. Bauer (Ed.), *Proceedings-XIII International Symposium on Biomechanics in Sports* (pp. 119-122). Lakehead University, Thunder Bay, Ontario, Canada.
- Davlin, C. D., Sands, W. A., & Shultz, B. B. (2004). Do gymnasts "spot" during a back tuck somersault? *International Sports Journal*, 8, 72-79.
- FIG [Fédération Internationale de Gymnastique] (2009). Code of Points – Men's Artistic Gymnastics. Retrieved from <http://figdocs.lx2.sportcentric.com/external/serve.php?document=1966>
- Fink, H. (1988). The biomechanics of release-regrasp skills in gymnastics. In *Men's Judges Certification and Education Manual* (Model 5, pp. 10-12). Vanier City: Canadian Gymnastics Federation.
- Gervais, P., & Tally, F. (1993). The beat swing and mechanical descriptors of three horizontal bar release-regrasp skills. *Journal of Applied Biomechanics*, 9, 66-83.
- Heinen, T. & Velentzas, K. (2007). MEKÖS-GYM – Mehrkörpersimulation im Gerätturnen [Multi-body simulation in gymnastics]. *Leon**, 2, 30-31.
- Hecht, H., & Savelsbergh, G. J. P. (2004). Theories of time-to-contact judgement. In H. Hecht & G. J. P. Savelsbergh (Eds.), *Time-to-contact* (pp. 1-

- 11). Amsterdam: Elsevier Science Publishers.
- Hiley, M. J., & Yeadon, M. R. (2005). Maximal dismounts from high bar. *Journal of Biomechanics*, 38, 2221-2227.
- Hiley, M. J., & Yeadon, M. R. (2007). Optimization of backward giant circle technique on the asymmetric bars. *Journal of Applied Biomechanics*, 23, 300-308.
- Hiley, M. J., Yeadon, M. R., & Buxton, E. (2007). Consistency of performances in the Tkatchev release and re-grasp on high bar. *Sports Biomechanics*, 6(2), 121-130.
- Holvoet, P., Lacouture, P. & Duboy, J. (2002). Practical use of airborne simulation in a release-regrasp skill on the high bar. *Journal of Applied Biomechanics*, 18, 332-344.
- Kerwin, D. G., Yeadon, M. R., & Lee, S. C. (1990). Body configuration in multiple somersault high bar dismounts. *International Journal of Sport Biomechanics*, 6, 147-156.
- Knoll, K. (1999). *Entwicklung von biomechanischen Messplätzen und Optimierung der Sporttechnik im Kunstturnen [Development of biomechanical measuring stations and optimization of movement technique in gymnastics]*. Cologne: Sport und Buch Strauss.
- Krug, J. (1997). Muskulär-antriebsseitige und informatorische Anforderungen bei Absprüngen und Flugbewegungen in akrobatischen Sportarten. *Zeitschrift für Angewandte Trainingswissenschaft*, 4(2), 104-112 [Muscular and inforamatory demands in jumps and flight elements in acrobatic sports. *Journal of Applied Training Science*].
- Kwon, Y.-H. (1996). Effects of the method of body segment parameter estimation on airborne angular momentum. *Journal of Applied Biomechanics*, 12, 413-430.
- Latash, M. L. (2008). *Neurophysiological Basis of Movement* (2nd Ed.). Champaign, IL: Human Kinetics.
- Mikromak. (2008). *WINalyze 3D* (ver. 2.1.1). Berlin, Germany.
- Nissinen, M., Preiss, R., & Brüggemann, P. (1985). Simulation of human airborne movement on the horizontal bar. In D.A. Winter, R.W. Norman, R. P. Well, K. C. Hayes, & A. E. Patla (Eds.), *Biomechanics IX-B* (pp. 373-376). Champaign, IL: Human Kinetics.
- Prassas, S., Kwon, Y.-H., & Sands, W.A. (2006). Biomechanical research in artistic gymnastics: a review. *Sports Biomechanics*, 5(2), 261-291.
- Raab, M., de Oliveira, R. F., & Heinen, T. (2009). How do people perceive and generate options? In M. Raab, H. Hekeren, & J. G. Johnson (Eds.), *Progress in brain research: Vol. 174. Mind and motion: The bidirectional link between thought and action* (pp. 49-59). Amsterdam: Elsevier.
- Roy, F. D., & Tomlinson, R. D. (2004). Characterization of the vestibulo-ocular reflex evoked by high-velocity movements. *The Laryngoscope*, 114, 1190-1193.
- Shapiro, R. (1978). Direct linear transformation method for three-dimensional cinematography. *Research Quarterly*, 49, 2, 197-205.
- Von Laßberg, C., Mühlbauer, T., & Krug, J. (2003). Spatial orientation during fast body rotations in horizontal plane. In W. L. Schöllhorn, C. Bohn, J. M. Jäger, H. Schaper, & M. Alichmann (Eds.), *European Workshop On Movement Science. Mechanics-physiology-psychology* (p. 96). Köln: Sport und Buch Strauß.
- Vickers, J. N. (2007). *Perception, cognition, and decision training. The quiet eye in action*. Champaign, IL: Human Kinetics.
- Yeadon, M.R. (1990a). The simulation of aerial movement. II. A mathematical inertia model of the human body. *Journal of Biomechanics*, 23, 67-74.
- Yeadon, M.R. (1990b). The simulation of aerial movement. III. The determination of angular momentum of the human body. *Journal of Biomechanics*, 23, 75-83.

Yeadon, M.R. (1997). Twisting double somersault high bar dismounts. *Journal of Applied Biomechanics*, 13, 76-87.

Yeadon, M. R., & King, M. A. (2008). Biomechanical simulation models of sports activities. In Y. Hong & R. Bartlett (2008). *Routledge Handbook of Biomechanics and Human Movement Science* (pp. 367-379). New York, NY: Routledge.

Yeadon, M. R., & Morlock, M. (1989) The appropriate use of regression equations for the estimation of segmental inertial parameters. *Journal of Biomechanics*, 22, 683-689.

Coresponding author:
Thomas Heinen,
German Sport University Cologne,
Institute of Psychology,
Am Sportpark Müngersdorf 6,
50933 Cologne,
t.heinen@dshs-koeln.de

AGE-RELATED DEVELOPMENT OF RUN-UP VELOCITY ON VAULT

Stefan Brehmer & Falk Naundorf

Institute for Applied Training Science, Leipzig, Germany

Original research article

Abstract

The run-up velocity on vault is described in many publications as an important factor to generate the energy for the subsequent motion segments of a vault. For a high run-up velocity both, biological backgrounds and empirical investigations show a steady increase in speed until the start of men's senior gymnastics age. Different mechanisms are responsible for this circumstance. Thus the increases of the running velocity during childhood and up to pubescence are due to primarily informational or coordinative development. From the beginning of puberty the faster sprint performance, especially in male gender, can be explained by conditional developments based on changed hormones level. To proof the explanations we compared the age related velocity in different stages of motor development, using run-ups of the last four years at various high level competitions. There is an increase in the velocity up to the end of men's junior gymnastics age, followed by stagnation in senior age. The speed increase in pubescence and adolescence do not differ. Therefore coordinative and conditional factors determined the development of run-up velocity equally.

Keywords: *age-related, development, run-up velocity, vault, men's gymnastics.*

INTRODUCTION

The competitive sports in general, especially gymnastics, are characterized by a continuous development and therefore constantly growing prerequisites on athletes. To meet these requirements a correspondingly high expression of performance parameters is needed and has to be supported with the uncovering of reserves in performance development.

A Vault consists of seven sections, run-up, hurdle, take-off, first phase of flight, support, second phase of flight and landing (Dillman, Cheetham & Smith, 1985; Sands, 2003a). One possible reserve on vault is seen in the expression of the approach velocity, whose great importance for a successful execution is mentioned in many specific gymnastics publications (Takei, 1988; Sands, 2000; Tashiro, Takata, Harada,

Kano & Yanagiya, 2008). Krug (1986), Hess (1993) and George (2010) mentioned the creation of the necessary energy requirements in the preliminary motion stages (run-up, hurdle, take-off) to fulfil the requirements of a difficult vault as well as possible. Brüggemann and Nissinen (1981) calculated a significant correlation of the approach velocity with height and width of the 2nd Phase of flight in handspring vaults. There is a positive correlation between run-up speed and score (Sands & Cheetham, 1986; Takei, 1988; Sands & McNeal, 1986; Takei, Blucker, Dunn, Myers and Fortney, 1996). Krug, Knoll, Köthe and Zoicher (1998) and Tashiro et al. (2008) also point out, that a faster run speed benefit a higher score. Own studies (Brehmer, Naundorf, Knoll, Bronst & Wagner, 2008) show a weak correlation between the run-up velocity of forwards vaults (according to the International Code of Points (Federation

international de Gymnastique, 2009) jumps are divided into five groups, three are relevant. Group III (handspring type) and IV (Tsukahara/Kasamatsu) are forward type vaults, in group V (round off entry/Yurchenko-Type) the backward jumps are classified.) in men's artistic gymnastics and difficulty score (D-Score: $r = 0.39$) and also to the final score (F-Score: $r = 0.39$).

The measurement of run-up velocity is common in training and competition. In senior elite gymnastics necessary run up velocities were published, but measured with different methods (Takei, 1988; Sands, 2000; Tashiro, et al., 2008; Velickovic, Petkovic & Petkovic, 2011). The assessment of the run-up velocities in youth and junior age however is still considered as problematic. In particular, the growth rates in the different ages and stages of motor development until puberty are of interest to the training practice. Currently there is a lack of specific reference values in the trainability of locomotive speed.

Speed of limb movements described as a physical ability (Fleishman, 1963) is a coordinative and conditional determined performance requirement and important for run-up velocity. Hohmann, Lames and Letzelter (2002) assume that speed is based on the quality of information processing. Thus the basic speed is determined by the neural control and regulation processes (time programs) and inter-muscular coordination (Grosser, Starischka & Zimmermann, 2004). The foundation for improving speed is a highly functional interaction between individual muscles (Nöcker, 1989) and the increase in the sub-areas of neuromuscular control and regulatory processes as well as the involved morphological structures and respective operating functional-energetic processes (Grosser et al., 2004).

At the same Grosser et al. (2004) attributed the complex speed capability primarily to the speed strength. The great improvement in speed (Schmidtbleicher, 1994), which is largely dependent on force, is caused by the modified trainability of muscles. From a biological point of view,

force and speed associated mainly with the production of hormones, especially testosterone. Admittedly, testosterone is formed not before the onset of puberty in sufficient quantities. At the acceleration phase, which marks the approach on vault, the speed strength has a decisive role (Martin, Nicolaus, Ostrowski & Rost, 1999).

Grosser et al. (2004) favour speed training from about the age of 7 as useful and recommended. Schmidtbleicher (1994) argues for a training of complex frequency speed-oriented movement skills in prepubertal phase, since after Bauersfeld and Voß (1992) all necessary coordinative conditions for the development of fast time programs are already given in this age. For Winter and Hartmann (2007) the speed ability pertains to those motor skills that are formed early in motor development and are already completed at the end of puberty.

Several publications pick up the issue of running velocities in empirical studies. Crasselt, Forchel, Kroll and Schulz (1990) documented the developments of various physical and athletic performance among schoolchildren in large-scale long-term studies. They (Crasselt et al., 1990) checked the development of locomotion speed with the help of the 60-meter run. Bös et al. (2009) extracted their findings from a nation-wide cross-sectional study. They use the 20-m sprint as the representative of locomotion speed in their tests of motor functions. An almost constant growth from the age of 6 respectively 7 to the age of 17 was recorded in both studies.

Previous sport – specific considerations have been limited to rough divisions in different age-ranges, but without providing precise age information. Brüggeman and Nissinen (1981) for example subdivided into groups of young gymnasts (schoolboys, 6.79 m/s velocity at first board contact), A-/B-squad (7.40 m/s) and world class gymnasts (7.98 m/s) and found evidence that largest run-up velocities are found in more high-performance groups. Sands (2000) investigated the maximum approach velocity and divided his sample

into categories including juniors and seniors. As a result of his analysis, he noted that the seniors (7.41 m/s) run significantly faster than the juniors (7.06 m/s).

From the current literature with relevance to the development of locomotion speed (Crasselt et al., 1990) or the action speed (Bös et al., 2009), can be deduced a steady and almost linear increase in running speed till the age of 18. Thus an increase in running speed is apparently linked to an increasing (training-)age. However, there were no guidelines how large annual rates of development should be, not to mention at what age an exercise of speed is particularly beneficial.

According to recent findings on the approach on vault are coordinative-

informational as well as conditional-energetic parameters. However it is not sure if one of the two factors has a greater influence on the development of run-up speed in gymnastics. So it is important to examine the research question whether and if so, when and what influential factors play a major role in gymnastics. This deficit of knowledge is to be examined more closely in this article. To answer the research question we use one popular way to classify the stages of motor development in Germany by Winter and Hartmann (2007). This classification is shown in Table 1. Findings on the development of the run-up speed should allow a classification of the velocity and their development rates.

Table 1. *Stages of motor development with age-range and characteristics (modified from Winter & Hartman, 2007).*

Stages of motor development	Age-range		Competition rules
	from	to	
“middle childhood”	6	9	
“late childhood”	10	12	regional and national rules for youth gymnastics
“pubescence” (early adolescence)	13	14	
(late) “adolescence”	15	18	Code of points (FIG, 2009) Junior competition
“early adulthood”	19	35	Code of points (FIG, 2009), Senior competition

METHODS

Participants

To answer the research question, a total of 1.165 runs by male athletes aged from 12 to 39 years (only the year of birth is decisive for their classification). were recorded in important national competitions (German Youth Championships, German Championships), international tournaments in junior level (International Junior-Team-Cup Berlin), as well as competitions at international level for seniors (World Cup Cottbus and Stuttgart, World Championships 2007).

Some athletes took part in a competition more than once a year, so the fastest approach of each gymnast per year was selected. To ensure a sufficient number of participants in any age, the age-range was limited from 12 to 25 years. Furthermore this age-range contains the relevant section of changes related to development and training. Focusing on elite gymnastics and in order to incorporate only the fastest athletes in the analysis a median split of the velocity per year was performed. Thus the

remaining number of approach velocities amounts to 335, with a total of 246 different athletes (Table 2).

Apparatus

For calibration and measurement a laseroperated velocity guard (LAVEG) was used. In all competitions the approach

velocity recorded using the same technique under similar conditions (Figure 1) with a calibration before every competition. In each case the LAVEG set in line with the approach, facing the vaulting table.

Table 2. Overview of the number (n) of runs in each age class in reduction of the data on the fastest run-up per year per athlete, structured according to stages of development.

	"late childhood" & "pubescence"			"adolescence"				"early adulthood"						Total	
Age	12	13	14	15	16	17	18	19	20	21	22	23	24	25	
n	47	34	32	35	30	40	40	9	16	13	17	15	11	6	335

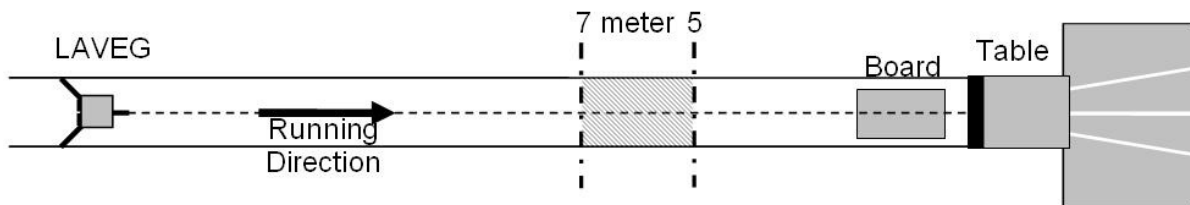

Figure 1. No dimensional sketch of the velocity measuring system in gymnastics competition.

Data analysis

Specifically developed software was used for the evaluation of the measured displacement data. For the following analysis of the run-ups, only the average speed between the 7th and 5th meter (v_{7-5} in m/s) before the vaulting table is of interest. Leirich (1979) determined the range between six and five meters in front of the vaulting table as the range which is directly in front of the hurdle. Data from other investigations (Trillhose, 1995; Brehmer & Naundorf, 2009) support the selected 2 m-section.

The statistical analysis is carried out using SPSS 17.0 and MS Excel 2003. To estimate the run-up velocities of young gymnasts and their underlying mechanisms three phases have been separated, according to the stages of motor development (Winter & Hartmann, 2007). These stages are the "late childhood" and "pubescence" (12-14-year-olds), the "adolescence" (15-18-year-

olds) and the "early adulthood" (19-25-year-olds). In addition to descriptive statistics, a regression analysis is carried out for the age-ranges described above.

RESULTS

The means of the run-up speed for the development phases are 7.3 m/s (12-14-year-olds), 8.0 m/s (15-18-year-olds) and 8.5 m/s (19-25-year-olds). The values listed in Table 3 for the selected stages.

It can be assumed that there is a basic increase across the stages of motor development. This is confirmed by data from the linear regression (the linear regression is the simplest relationship between interval-scaled data and is described by the equation $y = b * x + a$. The regression coefficient b is the expression for the increase of the line and the constant a is the intersection with the y-axis)(Table 4)

that prints the growth rate per year for the start of each development phase.

The increases (*b*) of the regression lines are almost identical (the run-up speed [m/s] is given with one digit after the decimal point (accuracy 10 cm/s), so the regression coefficient of 0.16 or 0.19 has to be evaluated as equal) at the 12- to 14-year-olds (*b* = 0.16) and 15- to 18-year-olds (*b* = 0.19), with comparable regression constant (*a*). In „early adulthood“ (19-25-

year-olds) a significantly increase (*b* = 0.02) is no longer observed (Table 4).

The regression is shown in Figure 2, using a scatter plot, which contains the respective regression lines for the development phases. In ”late childhood“ and ”pubescence“ (12-14-year-olds) the increases of the velocity are approximately the same as in the following section of the ”adolescence“ (15-18-year-olds). In ”early adulthood“ the starting rate nearly stagnated at a high level (> 8.1 m/s).

Table 3. Number (*n*), minimum (MIN), maximum (MAX), as well as mean (\bar{x}) und standard deviation (*s*) of the collected run-up velocities (*v*₇₋₅).

	Age-range of development phase			Total
	12-14 years	15-18 years	19-25 years	
<i>n</i>	113	135	87	335
MIN (m/s)	6.9	7.4	8.1	6.9
MAX (m/s)	7.9	9.1	9.2	9.2
\bar{x} (m/s)	7.3	8.0	8.5	7.9
<i>s</i>	0.2	0.3	0.2	0.5

Table 4. Number (*n*), regression constant (*a*) and regression coefficient (*b*) with confidence intervals (CI) of the collected run-up velocities separated in development phases.

	Age-range of development phase		
	12-14 years	15-18 years	19-25 years
<i>n</i>	113	135	87
<i>a</i>	5.27	4.82	8.13
<i>b</i> (CI 95%)	0.16 (0,12 - 0,20)	0.19 (0,15 - 0,23)	0.02 (-0,01 - 0,04)

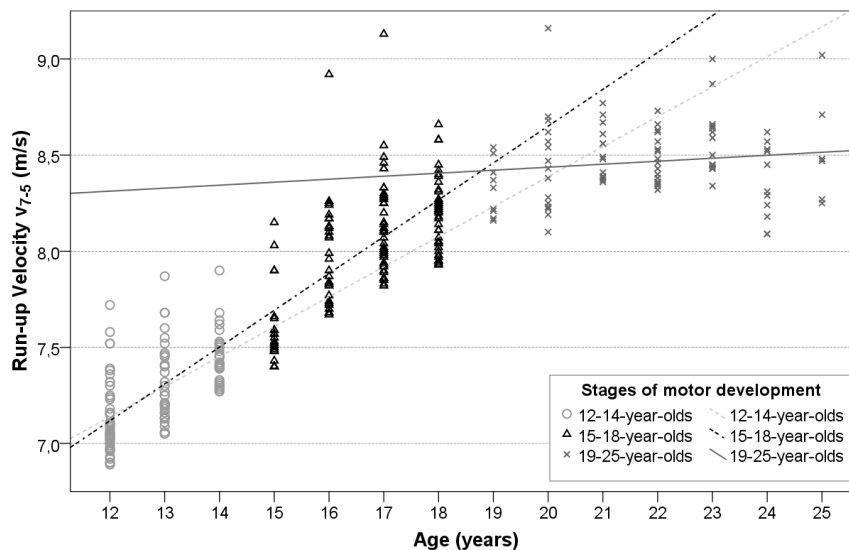

Figure 2. Scatter plot with marked development phase and associated regression line.

DICSUSION

The results show an increase in the approach velocity in "late childhood" and "pubescence" ($b = 0.16$) and in "adolescence" ($b = 0.19$, see Table 4). Keeping the overlapping confidence intervals (CI 95%) in mind the growth rates of these two development phases are approximately equal. Based on the results, the informational-coordinative and the conditional-energetic factors are equal in their influence. Thus the results confirm the assumption that both, the neuromuscular control and regulation processes and the energetic components play an equal role in the improvement of the speed. Acquired elementary speed skills in prepubertal phase such as the speed of action and speed of frequency (Grosser et al., 2004; Sands, 2003b) are also important factors. Developmental changes in puberty, such as the increased formation of testosterone and the resulting improved trainability of the muscles (Schmidtbleicher, 1994) and the assumed dominant significance of the speed-strength development (Winter & Hartmann, 2007), have therefore no major impact on the run-up speed. Training should pay attention to the mechanisms of the stages of motor development. In prepubertal age coordinative aspects such as frequency and action speed should be developed as well. After puberty training should be focused on strength development to use the hormonal conditions. .

After an initial increase a stagnation ($b = 0.02$) of the performance development could be observed with entry into the senior level. The absence of increments confirms the conservation of physical performance (Winter & Hartmann, 2007) in the literature.

The present results of the regression analysis provide the opportunity of assessing the individual rates of development. Annual amount of increase of athletes' velocity can be compared and classified with the regression coefficients. A corresponding comparison of the actual development with the development of the vaulting velocity on the basis of the

determined regression coefficients (for the prediction of development, the value of the first recording with the corresponding regression coefficient for each development phase are added and plotted in the chart) (b) is exemplified in Figure 3.

The performance of gymnast 1 und 2 is below the reference line. Gymnast 2 had a good development, but did not reach the reference line because his starting level is too low. The youngest gymnast (gymnast 3) shows an unsteady increase of the velocity. Nevertheless he is on the reference line. With the help of these examples becomes clear that the development is rarely as constant as shown by the prognostic data. We have to note critically, that the presented increasing rates correspond only to their respective stage of development. Therefore, the rates could not be valid for each age. For more accurate findings in the future a separately consideration of all ages is necessary.

CONCLUSIONS

In this paper, the age-related development of run-up speed on vault was demonstrated. The analysis of the approach velocity give a basic possibility to classify the vaulting velocity from "late childhood" to "early adulthood", and thus the opportunity to assess the individual performance and performance development of the athletes. The present data show a constant increase of the run-up speed till the senior age. In "late childhood" and "pubescence" (12 to 14 years, $b = 0.16$), and in "adolescence" ($b = 0.19$) nearly equal rates of development are detectable (see Table 4). In relation to the development of run-up velocity in gymnastics neither the informational-coordinative nor the conditional-energetic factors have a dominant role. An increase of the vaulting velocity in "early adulthood" is no longer recorded (Table 4 & Figure 2).

However, for the competitive sport in male junior gymnastics we can make a note that performance increases of about 0.2 m/s per year are classified as average.

This allows the coaches to compare the development of their athletes with the average growth rates and consequently evaluate the effectiveness of the training. To improve the running speed, gymnastic coaches use special training resources, in particular athletics (Brown, Ferrigno & Santana, 2000; Dintiman & Ward, 2003). In this regard coaches have to keep in mind the advice of Voß, Witt & Werthner (2007) that training only leads to success, if the close relationship between technique and strength training is respected. Thus both, coordinative and conditional aspects have to take into account.

Some authors (e. g. Grosser et al, 2004; Schmidtbleicher, 1994, Winter & Hartmann, 2007) expect high growth rates in speed of limb movements before the analyzed age-ranges. The elite gymnastics career starts about the age of five. There is no research known in this age-range. In addition, investigations in the women's artistic gymnastics and comparisons with other speed-oriented sports could give further information about the trainability of the cyclic speed.

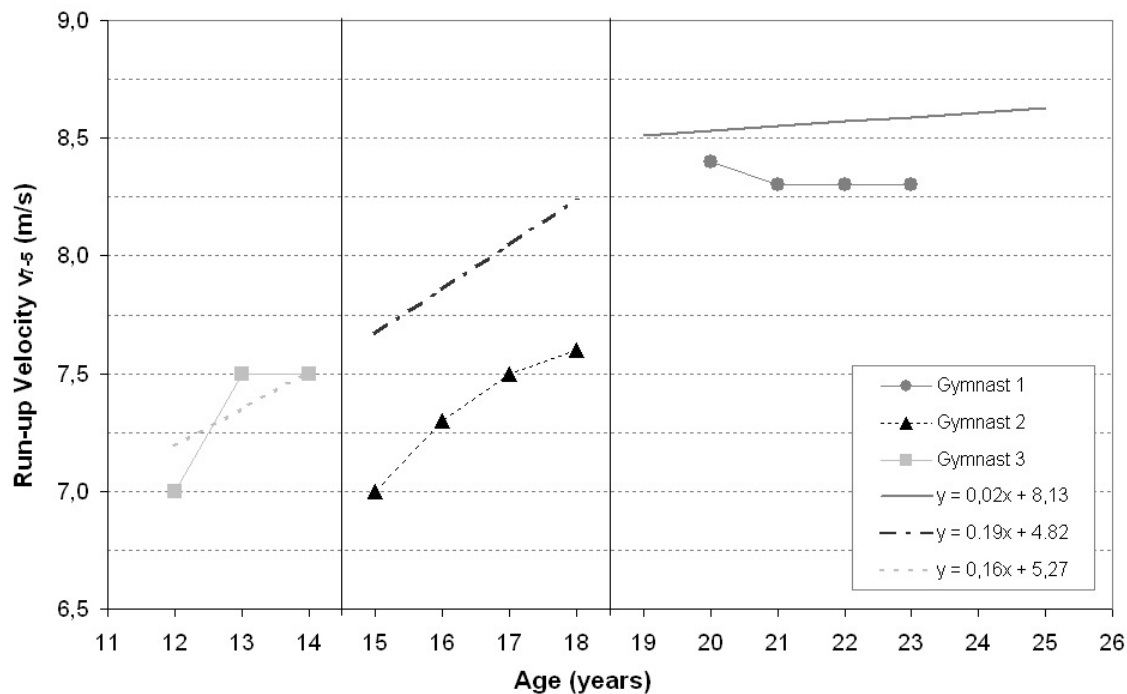

Figure 3. Comparison between real (gymnast x) and predicted development (gymnast $x + b$).

REFERENCES

Bauersfeld, M. & Voß, G. (1992). *Neue Wege im Schnelligkeitstraining*. Münster: Philippka.
 Bös, K., Schlenker, L., Büsch, L., Lämmle, L., Müller, H., Oberger, J., Seidel, I. & Tittlbach, S. (2009). *Deutscher Motorik-Test 6-18 (DMT6-18)*. Hamburg: Czwalina.

Brehmer, S. & Naundorf, F. (2009). Der Einfluss des Brettabstands auf die Flugphasen am Sprungtisch im Gerätturnen. In M. Krüger, N. Neuber, M. Brach & K. Reinhard (Eds.) *Bildungspotenziale im Sport*. Abstractband des 19. sportwissenschaftlichen Hochschultages der dvs, 16.-18.9.2009 in Münster (p. 270). Hamburg: Czwalina.

- Brehmer, S., Naundorf, F., Knoll, K., Bronst, A., & Wagner, R. (2008). *Anlaufgeschwindigkeit am Gerät Sprungtisch. 40. EnBW Turn-Weltmeisterschaft 2007 Stuttgart*. Forschungsbericht. Leipzig: Institut für Angewandte Trainingswissenschaft.
- Brown, L.E., Ferrigno, V.A. & Santana, J.C. (2000); *Training for Speed, Agility and Quickness*. Champaign: Human Kinetics.
- Brüggemann, G.P. & Nissinen, M. (1981). Analyse kinematischer Merkmale des Handstützüberschlages beim Pferdsprung. *Leistungssport, 11* (6), 537-547.
- Crasselt, W., Forchel, I., Kroll, M. & Schulz, A. (1990). *Zum Kinder- und Jugendsport – Realitäten, Wünsche und Tendenzen*. Leipzig: Pinkvoss.
- Dillman, C.J., Cheatham, P. & Smith, S.L. (1985). A Kinematic Analysis of Men's Olympic Long Horse Vaulting. *International Journal of Sport Biomechanics 1* (2), 96-110.
- Dintiman, G. & Ward, B. (2003). *Sports speed (3rd ed.)*. Champaign: Human Kinetics.
- Federation Internationale de Gymnastique (2009). *Code de Pointage for men's artistic gymnastic competition (Version 6)*. Lausanne: FIG.
- Fleishman, E. A. (1963). Factor Analyses of Physical Fitness Tests. *Educational and Psychological Measurement 23* (4). 647-661.
- Georg, G.S. (2010). *Championship gymnastics. Biomechanical techniques for shaping winners*. Carlsbad: Designs for Wellness Press
- Grosser, M., Starischka, S. & Zimmermann, E. (2004). *Das neue Konditionstraining für alle Sportarten, für Kinder, Jugendliche und Aktive*. München: BLV.
- Hess, R. (1993). Zum Problem des sporttechnischen Leitbildes und seine Übertragung auf das Training im Nachwuchsbereich. In G.-P. Brüggemann & J.K. Rühl (Hrsg.): *Biomechanics in Gymnastics: Conference proceedings* (pp. 333–338). Köln: Sport und Buch Strauss.
- Hohmann, A., Lames, M. & Letzelter, M. (2002). *Einführung in die Trainingswissenschaft*. Wiebelsheim: Limpert.
- Krug, J. (1986). Positionen zur Weiterentwicklung der Sporttechnik und des sporttechnischen Trainings in den akrobatischen Sportarten. *Theorie und Praxis der Körperkultur, 24* (3), 84-99.
- Krug, J., Knoll, K., Köthe, T. & Zocher, H.D. (1998). Running approach velocity and energy transformation in difficult vaults in gymnastics. In: H.J. Riehle & M.M. Vieten (Eds.), *XVI International Symposium on Biomechanics in Sports* (pp. 160-163). Konstanz: UVK – Universitätsverlag.
- Leirich, J. (1979). *Untersuchungen über die Technik und Trainingsmethodik der Stützsprünge unter Berücksichtigung der langfristigen Entwicklung der sportlichen Leistung – ein Beitrag zu Technikoptimierung und Methodologie der Leistungsdiagnostik im Gerätturnen*. Unpub. habilitation, Halle: Martin-Luther-Universität.
- Martin, D., Nicolaus, J., Ostrowski, C. & Rost, K. (1999). *Handbuch Kinder- und Jugendtraining*. Schorndorf: Hofmann.
- Nöcker, J. (1989). *Die biologischen Grundlagen der Leistungssteigerung durch Training (angewandte Physiologie)*. Schorndorf: Hofmann.
- Sands, W.A. & Cheatham, P.J. (1986). Velocity of the vault run: Junior elite female gymnasts. *Technique, 6* (3), 10-14.
- Sands, W.A. & McNeal, J.R. (1995). The relationship of vault run speeds an flight duration to score. *Technique, 15* (5), 8-10.
- Sands, W.A. (2000). Vault run speeds. *Technique, 20* (4), 5-7.
- Sands, W.A. (2003a). Biomechanics. In W.A. Sands, D.J. Caine & J. Borms (Eds.), *Scientific Aspects of Woman's Gymnastic*. (Medicine and Sport Science, 45, pp. 8-45) Basel: Karger.
- Sands, W.A. (2003b). Physiology. In W.A. Sands, D.J. Caine & J. Borms (Eds.),

Scientific Aspects of Woman's Gymnastic. (Medicine and Sport Science, 45, pp. 128-153) Basel: Karger.

Schmidtbleicher, D. (1994).

Entwicklung der Kraft und der Schnelligkeit. In J. Baur, K. Bös & R. Singer (Eds.). *Handbuch Motorische Entwicklung* (pp. 129-150). Schorndorf: Hofmann.

Takei, Y. (1988). Techniques used in performing handspring and salto forward tucked in gymnastic vaulting. *International Journal of Sport Biomechanics*, 4 (3), 260-281.

Takei, Y., Blucker, E.P., Dunn, J.H., Myers, S.A. & Fortney, V.L. (1996). A Three-dimensional analysis of the men's compulsory vault performed at the 1992 Olympic Games. *International Journal of Sport Biomechanics* 12 (2), 237-257.

Tashiro, K., Takata, Y., Harada, M., Kano, M., & Yanagiya, T. (2008). Comparativ studies about kinematics of maximal sprint running and running up in horse vaulting. In: Y.-H. Kwon, J. Shim, J. K. Shim, & I.-S. Shin (Eds.), *Scientific Proceedings of the XXVI International Conference on Biomechanics in Sports* (p. 581), Seoul, Korea: Seoul National University.

Trillhose, A. (1995). Zu Aspekten der Schrittgestaltung im Anlauf und des Brettlaufsprunges bei turnerischen Stützsprüngen am Pferd. *Leistungssport*, 25 (5), 37-39.

Velickovic, S. Petkovic, D. & Petkovic, E. (2011). A Case study about differences in characteristics of the run-up approach on the vault between top-class and middle-class gymnasts. *Science of gymnastics Journal*, 3 (1), 25-34.

Voß, G., Witt, M. & Werthner, R. (2007). *Herausforderung Schnelligkeitstraining*. Aachen: Meyer & Meyer.

Winter, R. & Hartmann, C. (2007). Die motorische Entwicklung des Menschen von der Geburt bis ins hohe Alter (Überblick). In K. Meinel & G. Schnabel (Eds.), *Bewegungslehre – Sportmotorik* (pp. 243-373). Aachen: Meyer & Meyer.

Corresponding author:
Stefan Brehmer
Marschnerstr. 29,
04109 Leipzig
Germany
E-mail: brehmer@iat.uni-leipzig.de

TOWARDS A SMART SPRINGBOARD (CASE STUDY)

Ivan Čuk¹, Samo Penič², Matej Supej¹ & Dejan Križaj²

¹Faculty of Sport, University of Ljubljana, Slovenia

²Faculty of Electrical Engineering, University of Ljubljana, Slovenia

Original research article

Abstract

Several measurement techniques can be used to analyze vaulting in gymnastics, however, no device is specifically developed for analyzing the springboard usage. After analyzing the literature about vaulting and the types of measuring devices used for analyzing physical parameters on vault we decided to develop a dedicated apparatus for measuring springboard actions. The new device is composed of a processor unit with LCD display and is connected to accelerometer sensors that are placed under the top desk of the springboard. The acceleration of the springboard desk during the jump is measured for two axes at 1000 Hz. From measured accelerations velocities are calculated by numerical integration and several parameters such as time to maximal springboard compression and maximal velocity at take-off are determined and displayed. The data is directly transferred to a PC for further analysis through an USB connection. Matlab software was used to record, filter and analyze the measured data. Results are in good agreement with simultaneously obtained results from the force plate and laser displacement sensor measurements (similar time and vertical velocity). With developed equipment it will be possible to determine typical springboard action parameters for individual gymnast, optimal springboard parameters for a required jump, to analyze repeatability of springboard jumps, to analyze transverse movements and to optimize training and its efficiency. The developed device has good potential for use as a fast information system as well as a device for suitable science/research projects in vaulting.

Keywords: *measurement technology, accelerometer, take off velocity, vault.*

INTRODUCTION

Vaulting has very old tradition starting already from Minoan Crete culture (1800-2500 years BC). Apparatus like wooden horse was already mentioned in 4th century as soldiers preparation apparatus. The wooden springboard was introduced (mentioned in documents) by Arhangel Tuccaro in 1599 (Čuk & Karacsony 2004). Vault was an official discipline already at the first modern Olympic Games in Athens in 1896. Nowadays, vault is a gymnastic discipline for men and women by the Code of Points (COP) (FIG 2009b, FIG 2009c).

For vaulting competitions (as a discipline) an official apparatus is required comprising a runway carpet, a springboard, a table and mats (FIG, 2009a). Through the centuries the springboard was changed in design and physical characteristics and by last apparatus norms (FIG, 2009a) the main springboard dimensions are shown in Figure 4.

Vault is a complex and short (not much more than 7 seconds in average) movement (Čuk & Karacsony 2004). The problem of human interaction with a springboard is important as human has to

adapt to the springboard elastic characteristics. Sands, Smith & Piacentini (2008) found each person has its own jump pattern and it is worth to study them. For this reason it is important to investigate the state of the art of the technology used to evaluate the vault and to search for new methods for improved usage of available technology. In particular, the investigation shows that many methods for analysis of the vault are available on the market but they are mostly used for research purposes and not for improvement and optimization of the gymnasts' vaulting techniques. The aim of our work was to reduce this lack and develop a device for analyzing the most important phase of the vault – the springboard actions. The device should be of low cost and easy to use so it could be used for both purposes – for research work as well as during vault training for analysis and optimization of the springboard usage.

For practical reasons we divide the vault into several important phases: approach, flight to the springboard, springboard actions, 1st flight phase, support, 2nd flight phase and landing (Čuk & Karacsony 2004). The velocity of runway depends on the difficulty of a vault. In general, easier vaults require lower velocities and vice versa. According to Soviet authors Antonov (1975) and Semenov (1987) the velocity should be from 3 to 5 m/s in the last five meters of run for simple direct vaults, about 7 m/s for women doing handspring vaults and 8 m/s for more difficult vaults. For male gymnasts who have to vault over a higher horse the velocity of run should be from 7.5 to 8.5 m/s for medium difficult vaults, 8.5-9.5 m/s for difficult vaults and over 10 m/s for vaults with double salto rotation velocity. The distance of flight from run to the springboard is by Antonov (1975) and Semenov (1987) for direct vaults between 2.30 and 2.80 m. The time of flight depends from the velocity of the run and the take-off force. Generally this time is between 0.24 and 0.30s. The feet are maximum 0.35 cm above the ground; females reaching slightly lower values for all parameters. From the

research done with 3D kinematic and Optojump apparatus Veličković, Petković, Petković (2010) noticed differences between the strategy of runway of the best gymnasts (in the middle of runway they decelerate for a moment) comparing to the average ones (their runway is accelerated all the time). According to Čuk and Karacsony (2004) for the vaults with a pre-element (round off) the distance of flight from run to the springboard is between 2.80 and 3.50 m, while the time is between 0.32 and 0.38 s.

Board contacts are divided into the compression phase and the take off phase. The first phase is characterized by extreme load and compression of a springboard while the second phase is characterized by the use of elastic reaction of a springboard and maximal force of take-off muscles (all hip, knee and ankle extensors, trunk extensors and shoulder abductor). In order to gain sufficient angular momentum the final take-off force is always eccentric behind the body center of gravity (BCG) (according to the direction of the jump) and in the direction of the jump (Figure 1).

The duration of board contact is very short, about 0.12 s (Table 1), which is a very low value. As a rule, if a gymnast has a contact mainly with a front part of foot on a board, the time is shorter while in case the contact is mainly on the whole foot area the board contact time is longer (Čuk & Karacsony 2004). This is also the reason why all pre-element vaults have a longer time of board support. The position of the feet on the board should be parallel, hip width apart and BCG should be in the center of the springboard according to the z-axis (left-right position) and toes should be placed 20 cm from the front edge of the springboard. In practice (Čuk and Karacsony, 2004) measurements show quite different results (Table2).

Ferkolj (2010) after the kinematic analysis reports for handspring double salto forward tucked at the moment of the take-off velocity in x axis 5.04 m/s, velocity in y axis 4.65 m/s and velocity in z axis 6.86 m/s; similar but slightly lower velocities were found by Cormie, Sands and Smith

(2004). Using electromechanical film Keränen, Moiso and Linnamo (2007) also obtained similar results for a Roche vault. Using force plate measurements Bolkovič and Čuk (2000) report that for simple jumps (squat and split jump) 6-6.5 of body weight (BW) force is need at take-off within 0.15 second time spent on the springboard. Using force plate and load cells Greenwod and Newton (1996) showed that 10.3 BW at the take-off is needed for a handspring forward. Bradshaw et al. (2010) analyzed variability of performing vault during the day to day training with a series of photo cells and contact mats and the results show that the runway velocity (coefficient of variability (CV) = 2.4-7.8%) and the board contact time (CV 3.5%) were less variable than the

first flight phase time (CV = 17.7%) and support time (CV = 20.5%). Sano et al. (2007) analyzed movement of 29 springboard points and segments with a force plate and a high speed camera. A model of only four segments produced almost the same accuracy as a 29-segment model; the simplified model is thus recommended as a more efficient method to measure board reaction force. Sands, Smith & Piacentini (2008) used magnetic sensors on a springboard to analyze the springboard dynamics during the take-off for handspring. According to the figures they showed the pattern of the curves for all sensors on the upper edge of the springboard were the same.

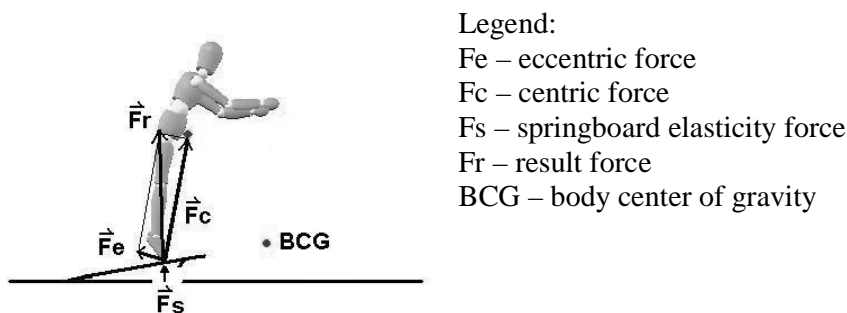

Figure 1. Directions of forces at take off by Čuk and Karacsony (2004).

Table 1. Time of board support (World Championship Qualification, Debrecen (HUN), 2002)(Čuk and Karacsony, 2004).

Board contact	Women	N	Men	N
Handspring jumps	0,12	22	0,12	27
Tsukahara jumps	0,12	12	0,12	37
Round of handspring backward jumps	0,15	18	0,14	11
Round of, 1/2 turn handspring forward jumps	0,15	13	0,16	2
Round of, 1/1 turn handspring backward jumps	0,16	9		

Table 2. *Position of feet according to springboard edge and horse edge (World Championship Qualification, Debrecen (HUN), 2002)(Čuk and Karacsony, 2004).*

<i>Women</i>	N	From springboard edge (m)	From horse edge (m)
Handspring jumps	22	0.41	1.12
Tsukahara jumps	12	0.44	1.24
Round of handspring Backward jumps	18	0.12	0.56
Round of, 1/2 turn handspring forward jumps	13	0.17	0.69
Round of, 1/1 turn handspring Backward jumps	9	0.15	0.81
<i>Men</i>			
Handspring jumps	27	0.34	1.04
Tsukahara jumps	37	0.34	1.05
Round of handspring Backward jumps	11	0.25	0.67
Round of, 1/2 turn handspring forward jumps	2	0.21	0.62

Table 3. *Advantages and disadvantages of technology used in vault researches.*

Technology	Advantages	Disadvantages
video technology	Used for fast information system, can be used on all apparatus	To obtain quantitative data it is time consuming and not appropriate in real time for training purposes
kinematic system for 2D and 3D analysis,	Very accurate data on kinematics	It is time consuming and not appropriate in real time for training purposes, high costs
force plate, load cells,	Very accurate data on dynamics	Special podium conditions are needed, hard to afford in gym, high costs
contact mats,	Very accurate data on time	Low durability
photo cells,	Very accurate data on time, low costs	Used only for runway
Optojump,	Very accurate data on time, distances, frequencies	Used only for runway, needs flat surface, high costs
electromechanical film,	Accurate data on time, forces	Not on the market
magnetic sensors	Accurate data on time, acceleration and velocity	Not on the market

Bradshaw et al. (2010), Dolenc et al. (2007), Bricelj et al. (2008) found that for optimal preparation for the competition the variability of vault parameters should be optimized and stabilize them. Furthermore, for progression of the vault it is important to know if gymnast can produce such data that enable more difficult vaults.

Most often used technologies in vault research and training processes are presented in Table 3. All these technologies have advantages and disadvantages. For instance, Optojump is a sophisticated technology that enables quite accurate position detection at several positions, but can only be used on flat surfaces (not on the springboard). Systems providing (almost) real time results are for instance video systems, photo cells and contact mats.

The quality of the vault strongly depends on appropriate usage of the springboard. Therefore we concentrated our research efforts to develop and analyze a system/device that would be capable of detecting and analyzing this extremely dynamic event. The system should be relatively low cost but sufficiently accurate and easy to use. Low cost mostly requires use of miniature electronics in conjunction with accurate but low cost sensors. Accuracy is mostly related to appropriate selection of sensors and R&D efforts for their optimal usage while ease of use is related to suitable selection of most relevant parameters that clearly determine the quality of the springboard usage. According to already mentioned research results we decided to evaluate the quality of the springboard usage through the following parameters:

- time of feet contact on the springboard,
- maximal velocity of the springboard during the take-off phase,
- time to maximal springboard velocity,
- time to maximal springboard compression (zero velocity).

In the following it will be shown that these parameters provide sufficient information on the quality of the

springboard usage. In addition to the selected parameters, it would be advantageous to be able to detect and analyze also the lateral movement during the gymnast contact with a springboard as well as determine the point of toes contact on the springboard.

In order to obtain the desired parameters, two different approaches can be used. We can either use a general purpose solution as for instance use a commercial tensiometric force plate or develop a dedicated device that would be optimized for the desired application. The advantage of a general purpose solution is obvious as it is commercially available and as such received "ready for use", the repeatability and accuracy of the device is known and procedures for measurements are set. On the other hand, the interpretation of the results is left to the experience/expertise of the user. A clear advantage of developing a dedicated system for analysis of the springboard usage is in simplicity of usage, portability and price.

METHODS

In order to develop a device capable of determination of relevant parameters during springboard usage we concentrated on several possible solutions as shown in Table 4.

According to a short review of development options described in Table 4 and future trends in microelectronics we decided to develop a device based on Phillips ARM7 processor from the chip family LPC21xx. This family of chips facilitates a variety of chips which are replacable (the same software can be applied to all of them) enabling selection of a most suitable chip in the very late stage of development or even before the final production. Beside selection of a suitable chip a decision of suitable peripheral units and transducers/sensors should be made. In particular, selection of appropriate transducers that would be suitable for achieving the desired operation of the device is crucial for optimal performance

and the price of a system and in fact it also influences complete hardware and software development. Table 5 presents a (limited) review of possible transducers to accomplish the desired task. The MEMS

based accelerometers seem to be most reasonable solution that fulfils several design criteria: low cost, portability, ease of use, accuracy (Močnik and Križaj (2008).

Table 4. *Comparison of possible development approaches.*

	Advantages	Disadvantages/deficiencies
Measurements with portable computer, general purpose Data Aquisition Systems (DAQ) and appropriate sensors	No need to develop hardware and only concentrate on software and appropriate sensor usage	Limited mobility, high cost, limited usage of suitable sensors, short battery life, ...
FPGA (Field-programmable gate array) card with SPARTAN-3	Very fast operation, very flexible chip	Very complex, high cost of development
Development board with PIC18 processor	Very common, low cost, easy to use	Slow operation, high cost of professional development tools
Development board with ATMEGA16	Very common, low cost, easy to use	Slow operation, sensitive to electrostatic breakdown
Development board with ARM7	Most recent platform, simple architecture, low cost, low power consumption, availability of development tools, USB support	Slower than FPGA, relatively small amount of internal memory

Table 5. *Selection of possible transducers.*

	Advantages	Deficiencies
Non laser optical sensors	Well know operation, output as distance	Low cost, less accurate, mechanical construction needed
Laser based sensors	Could be very accurate, output as distance	High cost, mechanical construction needed
Force sensors (in particular strain gage)	Similar as used in tensiometric plates, accurate if well designed, direct force output	Not necessary low cost, well designed construction needed, temperature dependant
Electromechanical sensors	Various kinds. Could be very accurate in conjunction with optical reading, output as distance	Cost depending on required accuracy, ...
Micro-electro-mechanical (in particular MEMS accelerometers)	Low cost at high accuracy, output as acceleration, very miniature, easy mounting	Velocity and distance obtained by integration, calibration required

MEMS devices are miniature chips made by microelectronic technology with addition of some technological steps enabling development of miniature mechanical systems. MEMS accelerometers are micron sized mechanical systems with a fixed and a moving mass. A variety of mechanisms are used to detect miniature movements of the moving mass relative to the fixed one. In most cases, small capacitance changes are measured. Most of modern MEMS accelerometer chips incorporate also electronic part which task is to amplify the signals and prepare them for analog or digital output. The output of a MEMS accelerometer is directly proportional to the measured acceleration.

Such devices are nowadays commonly used in cars to detect crashes and fire the airbags, in computers to stop the disk in case of dropping, in mobile phones, cameras, GPS systems etc (Kavanagh and Mentz (2008), Zeng and Zhao (2011)). Due to their small size and accuracy they are also very suitable for use in sports (Križaj and Mihevc (2007)). Due to broad usage of MEMS accelerometers and microelectronic technology used for their production these devices are low cost and with good performances. We decided to develop our system on chips from ADXL family from Analog Devices. These chips are known to be very accurate, cover a variety of different acceleration ranges and are low cost.

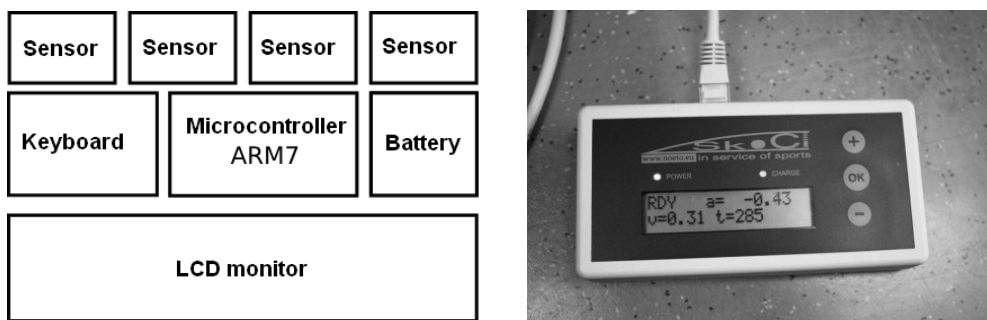

Figure 2. Block diagram with hardware and appropriate periphery and final main board.

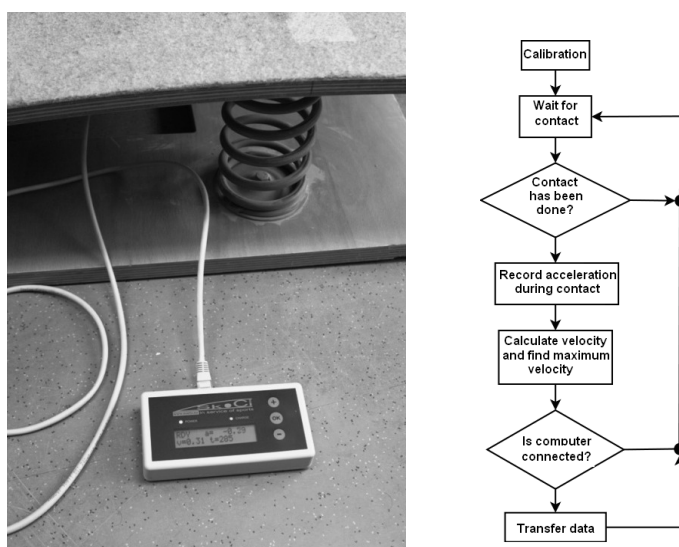

Figure 3. Device with sensor connected under the springboard and block diagram of measuring process.

The block diagram of the designed device and the final developed device are presented in Figure 2. The device is capable of measuring acceleration for two axes at 1000 Hz with possible extension to two additional sensors. The sensors can be either with analog or digital output; currently the device is configured/programmed for usage of analog sensors. In our investigation we used 5g to 10g sensors from Analog Devices. The device has only three buttons, currently mainly used for the calibration procedure. The calibration of the sensors before usage increases accuracy of measurements as the output values can depend on the temperature and other environmental conditions. The calibration procedure is very simple and is based on the fact that accelerometers are sensitive to the earth gravity which can be fruitfully used for the calibration purpose. The device operates most of the time in the stand-by mode that significantly prolongs the battery life. The measurements start as soon the device detects a small acceleration change indicating the start of the jump onto the springboard. After the measurement is performed the device calculates the velocity by numerical integration of acceleration values and by appropriate filtering. Complete acceleration values and velocity values are stored in internal memory and can be used for additional processing, in particular for a transfer to a personal/portable computer. As soon as the jump is finished the build-in LCD display presents most important calculated values such as maximal springboard velocity at take-off and time to maximal velocity. Other values as described in introduction can be shown as well.

The accelerometer sensor was fixed in the middle and under the springboard, 0.25 m from the front edge of the springboard (where the toes should be placed at the most efficient take off).

Several experiments were performed in order to analyze the device behavior and suitability: / - the measured results were compared to the results obtained by

distance measurements using a high accuracy laser system,

- the results were compared with simultaneously measured forces by a tensiometric force-plate (AMTI, FORCE and MOTION; model BP622 600 -2K),

- different types of jumps were performed (drop jumps from 0.4 m high box, and 3 - 4 steps runway and jump from a springboard) by non gymnasts in order to evaluate the suitability of the device.

Matlab. 7.0 computer software was used to analyze the measured signals. Acceleration and velocity are related through the derivative/integral

$$a(t) = \frac{dv(t)}{dt} \Leftrightarrow v(t) = v(t_0) + \int_{t_0}^t a(t) dt$$

(1).

Since the sensor measures acceleration (also gravitational) the velocity profile is obtained by integration of acceleration according to equation (1). Numerical integration requires some precautions since already small measurement errors or errors due to noise by the surroundings or electronics are significantly increased during numerical integration (Žagar, Križaj, (2005)). As a consequence raw data were additionally filtered with a moving average and a Butterworth low pass filter before numerical integration.

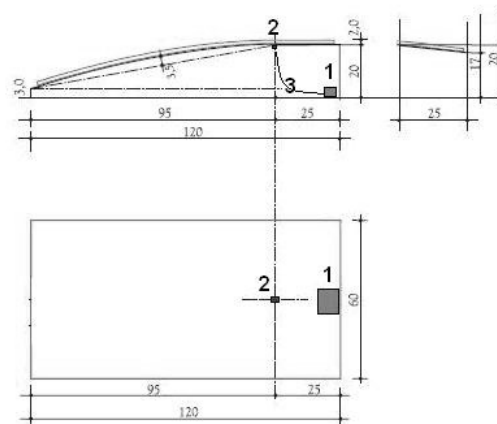

Figure 4. Springboard by FIG norms (FIG, 2009a) and placement of 1-processor with monitor, 2-sensor, 3-wires.

RESULTS

1. Raw acceleration measurements and calculation of velocity profile

Figure 5 presents raw measured acceleration data for a typical jump onto a springboard and calculated velocity profile according to eq. 1. The axes in the figure are inverted. This means that positive axis for

acceleration points upwards while positive axis for velocity points downwards (toward earth). It can be seen that the sensors is very sensitive and detects also very small acceleration changes (2 mg, where 1 g refers to the earth gravity acceleration - approx. 9.8 m/s²). It should be noted that maximal accelerations indicate maximal changes of velocity and not directly maximal velocities.

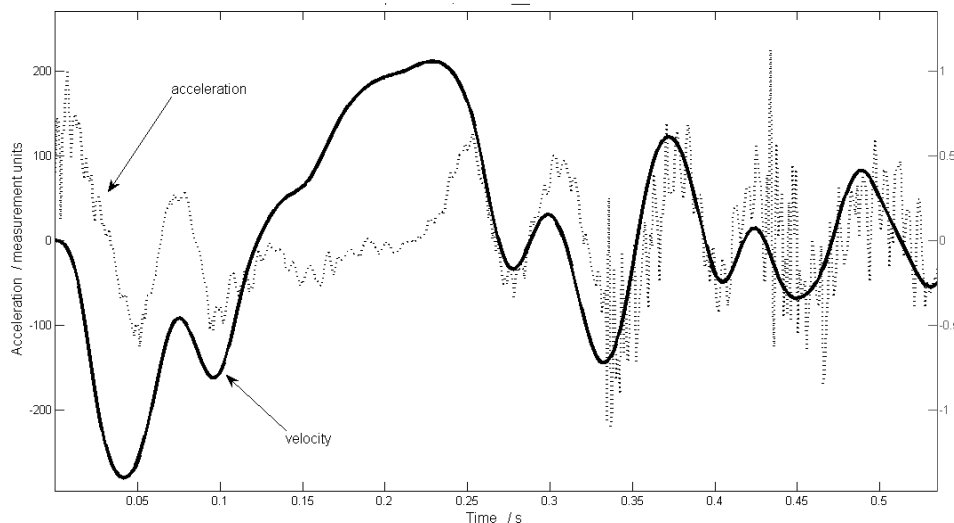

Figure 5. Raw acceleration data and numerically calculated and filtered velocity profile for a typical jump onto the springboard.

2. Comparison with force measurements and laser distance measurements

It can be assumed that the force (F) of spring compression (in particular in case standard solenoid springs are used – as in our case) is linearly related to the compression distance ($F = kx$), where x is the compression distance and k is the spring compression constant. Such a relation can be in particular expected in the middle range of compressions. In order to perform this comparison, the velocity curve was integrated once more according to the relation between the compression velocity and the distance

$$v(t) = \frac{dx(t)}{dt} \Leftrightarrow x(t) = x(t_0) + \int_{t_0}^t v(t)dt \quad (2)$$

Figure 6 shows a comparison of force measurement and acceleration measurement

with consecutive velocity and distance determination from the measured acceleration for two consecutive jumps (the gymnast jumped onto the springboard and landed again on the springboard). The obtained curves are very similar and thus indicate that the relationship between the force measurement and the acceleration measurement can indeed be obtained. The developed device seems more sensitive to vibrations what is actually advantage in defining the proper gymnast's action. Human body has numerous wobbling masses and such disturbances for action on a springboard can be accurately detected with a developed system.

Another test has been performed using a high accuracy laser distance measurement system. From obtained vertical distances we have calculated the velocities by numerical derivation (the curve needs to be smoothed and filtered before derivation). As shown in

Figure 7 very good agreement has been obtained between velocities obtained by numerical derivation of the laser measured distances and velocities obtained by

integration of measured accelerations. This confirms correct usage of the developed device.

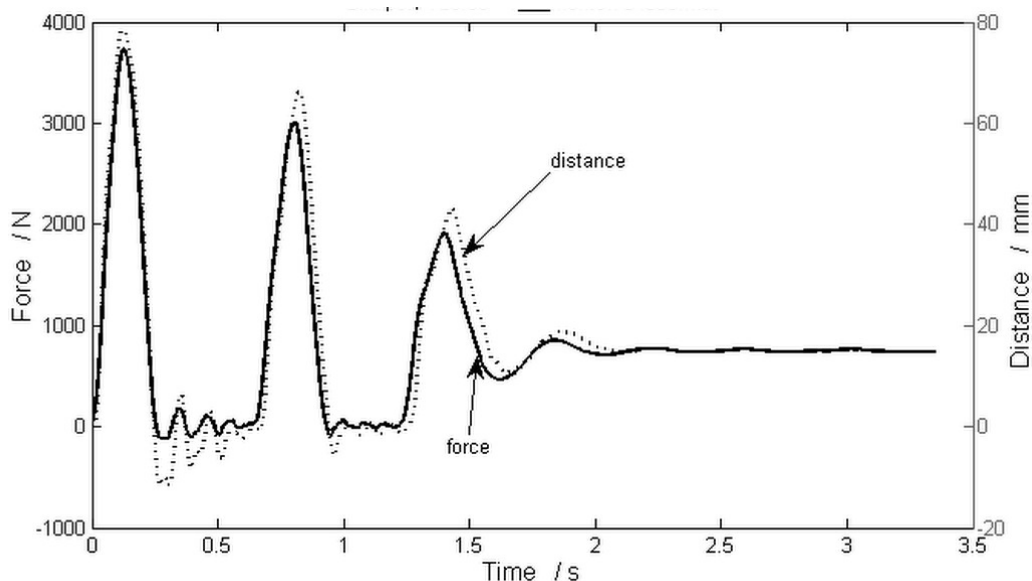

Figure 6. Comparison of vertical force measured with a tensiometric force plate and distance calculated from vertical springboard acceleration with new device vs time.

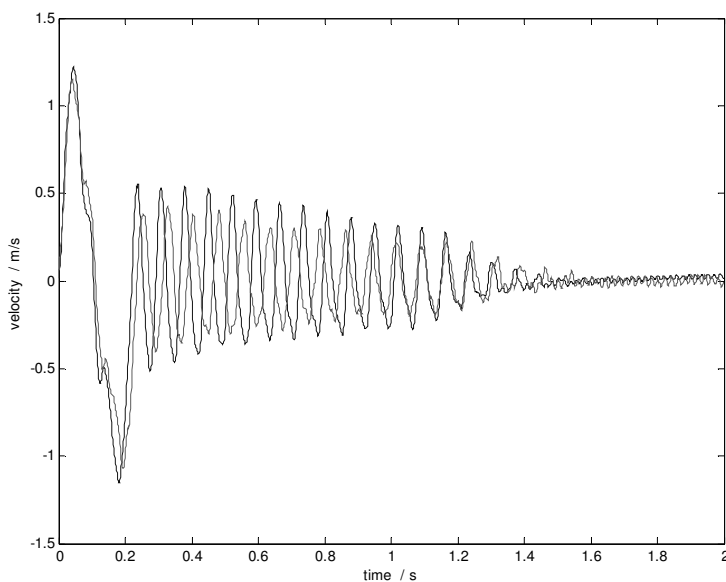

Figure 7. A comparison of springboard velocity obtained by measuring acceleration and the velocity obtained from distance measurements with a laser distance sensor.

3. Determination of significant points on the velocity/time curve

Several important points can be identified on the vertical velocity/time curve that can be used to analyze performance of a springboard usage (Figure 8). Before any action on the springboard its vertical velocity is zero. When a gymnast touches down the springboard it starts to move downward accelerated. Because of the counter force of the springs the velocity

decelerates and in the moment of maximum compression the vertical velocity is zero again. After this point the springboard is moving upward and the vertical velocity of the springboard increases and reaches maximum just before the toes of the gymnast release from the springboard (comparing times from high speed camera and accelerometer). After this moment the velocity of the springboard reduces and damped oscillates toward zero.

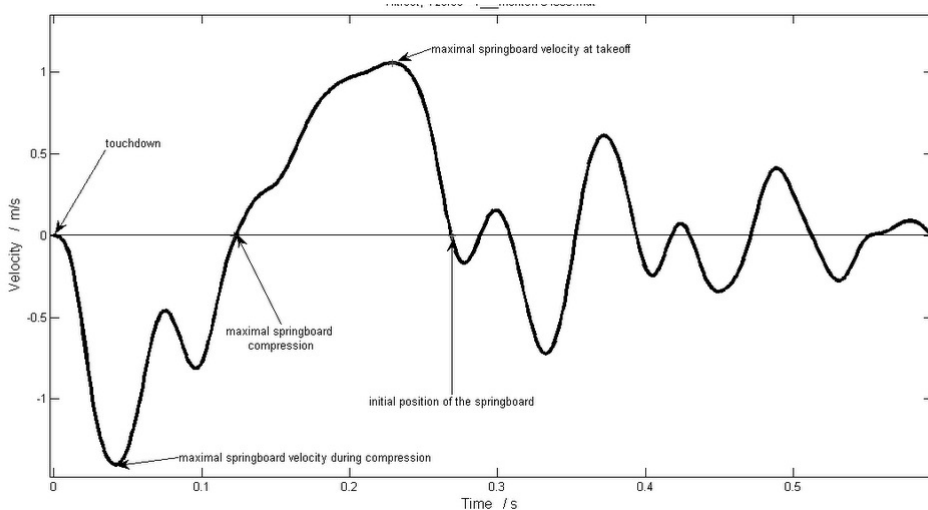

Figure 8. Typical vertical velocity [m/s]/time[s] pattern.

From the vertical velocity/time curve we can identify the following parameters:

- time to the first maximal negative velocity,
- maximal negative velocity
- time from the touch down to the most compressed springboard (zero velocity):
- time to maximal positive velocity
- maximal positive velocity
- time to initial position of the springboard (zero velocity)

Correct interpretation of determined parameters is not a trivial task as many parameters can influence them; in particular, the gymnasts body composition (mass, height, wobbling mass) and execution of a jump. Short times on a springboard could indicate very stiff body. Curve with only one peak in negative direction could

indicate very good stiffness, take off phase with one peak indicates suppose very good synchronized muscle action. We expect that the time to the first maximal negative velocity and time to the most compressed springboard (zero velocity) demonstrate dynamics of the landing phase onto the springboard. Furthermore, calculated compression (in meters) is directly related to the compression force and thus to the potential energy that the gymnast can exploit during take-off from the springboard (compression depends on body translation momentum and muscle force; however both are affected by the body weight). The first phase of the jump starting from the touchdown to the maximal springboard compression could indicate the capability of the gymnast to store the energy mostly into the springboard (springs) and tendons. The second phase starts from the maximal springboard compression to the take-off.

The efficacy of this phase can be determined from the difference of times between the maximal positive velocity and the time to maximal springboard compression. Several peaks on the take off

curve could indicate non adequate consecutive, synchronised and rhythmic action from different extensors – e.g. gastrocnemius, quadriceps, erector spinae).

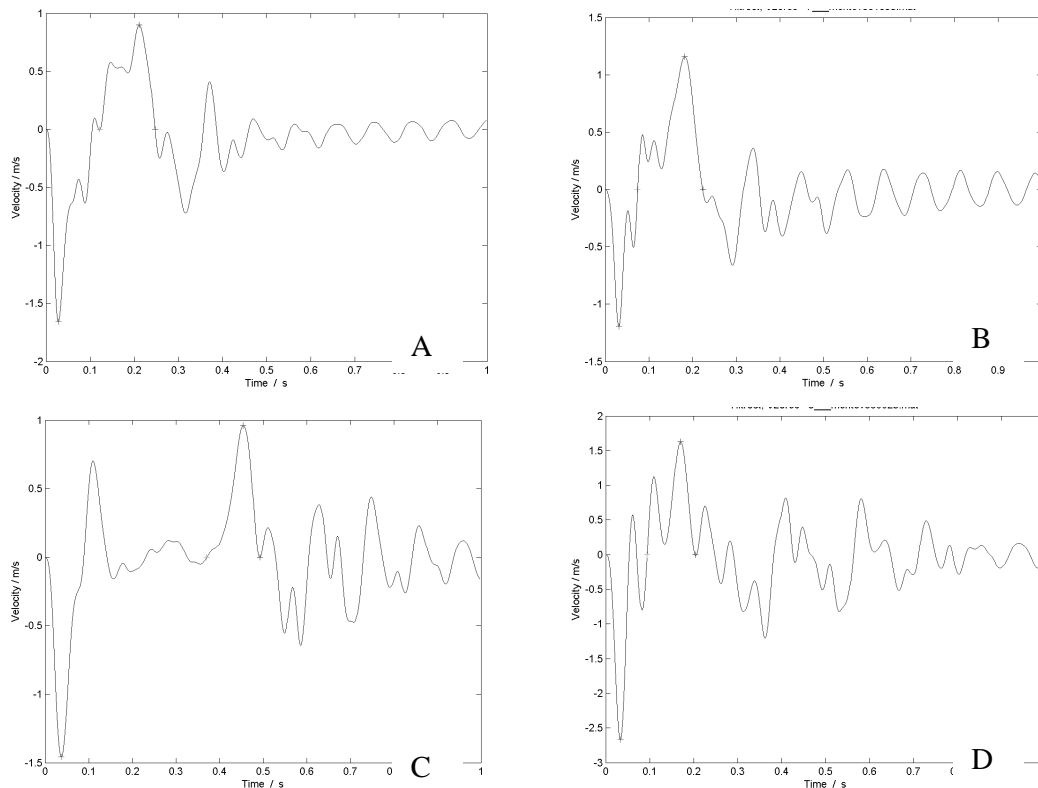

Figure 9. Vertical velocity profiles for four different types of jumps. A – drop jump from the box with landing to springboard with full feet, and take off with toes; B – from 3-4 steps runway jump on springboard with full feet and take off with toes, C – drop jump from box on toes until the half squat position and take off with knees mostly (heel is not placed on the surface at any time), D – from 3-4 steps runway jump on springboard with toes first than heel and very energetic take off from toes.

One particularly important feature of the developed device should be identification of different types of jumps that could serve for evaluation of performances as well as capabilities of the gymnast for a particular vault. Figure 9 presents velocity/time profiles for four different types of jumps: A – is a drop jump from a box with landing to a springboard with full feet and take-off with toes; B – is a jump onto a springboard from 3-4 steps runway with full feet and take-off with toes, C – is a drop jump from a box on the toes is similar to those on the force plate for take-off from a squat position (curve

until the half squat position and take-off with knees mostly (heel is not placed on the surface at any time), D – is a jump onto a springboard from 3-4 steps runway with toes first than heel and very energetic take off from the toes. While A and B curves are similar in compression, they do express slight difference in the take-off phase. It seems a person who had performed the jump B had problems with the take-off action. Jump C clearly shows an amortization phase, the time for getting into a half squat position and the take-off curve with one peak only). Jump D shows the shortest time of a jump and the highest take-

off velocity, however the curve pattern is similar to the jump A and B with more peaks during the take-off phase indicating non linear take-off action (slight delays, non adequate synchronization between the human and the springboard, non adequate timing of the take-off muscles action etc).

CONCLUSIONS

Correct springboard usage is crucial for performance of optimal vaults. As the event of the jump onto the springboard and the take-off is very dynamic and lasts typically less than 0.2 s it cannot be well interpreted by human eyes only. Some help of technology is desired. As a consequence we identified some possible technologies that can be used for measurement of the jump performance and analysis of usage of the springboard. In order to provide the springboard users an affordable and yet efficient technology we developed a device that is easy to use, of small dimensions and as such very portable and has low cost. The concept is based on usage of miniature acceleration sensors that are mounted below the top springboard desk. Due to miniaturization the sensor does not influence the gymnast performance and yet provides very accurate measurements. The evaluation of a jump is based on interpretation of the data obtained from measured acceleration. In particular, the velocity profile is calculated and several typical parameters are identified such as time to first negative maximal velocity, time to maximal compression, maximal springboard compression, maximal positive velocity during take-off and time to maximal positive velocity. These parameters have been related to the stiffness of the gymnast during the jump, the potential energy stored in the springboard, gymnasts take-off muscle action, etc. The performance of the developed device has been compared with other measurement techniques in particular with force plate measurements and measurements of springboard compression with a laser distance measurements. In both cases a

comparison revealed similar patterns and confirmed the selected choice of technology. The developed device was currently tested only in the laboratory environment so the next phases of research would include also measurements in real environment. It is expected that with the developed equipment the user would be able to:

- determine typical springboard action parameters per gymnast,
- determine optimal springboard parameters for required jump,
- analyze repeatability of springboard jumps,
- analyze transverse movements,
- optimize training and its efficiency.

In near future we will concentrate our efforts to determine reliability as well validity of the presented approach and the developed device. The device has a potential for use as a fast information system of gymnasts' performance on the springboard as well as a device suitable for science/research projects in vaulting.

REFERENCES

- Antonov, L. (1975). *Preskoci za žene* [Vaulting for Women]. Moskva: Fiskultura i sport.
- Bolkovič, T., & Čuk, I. (2000). Differences between men and women biomechanic characteristics of take off of simple horse jumps. In: ČOH, Milan (ed.), JOŠT, Bojan (ed.). *Biomechanical characteristics of technique in certain chosen sports*. Ljubljana: Faculty of Sport, Institute of Kinesiology, 20-24.
- Bradshaw E., Hume, P., Calton M., & Aisbett, B. (2010). Reliability and variability of day-to-day vault training measures in artistic gymnastics, *Sports Biomechanics* 9(2), 79-97.
- Bricelj, A., Dolenc, A., Bučar Pajek, M., Jakše, B., Čuk, I., Čoh, M. (2007). Reliability of runway characteristics of vault in women artistic gymnastics. In: SMAJLOVIĆ, Nusret (ed.). *Zbornik naučnih i stručnih radova-dodatak*.

Sarajevo: Univerzitet, Fakultet sporta i tjelesnog odgoja, 32-35.

Cormie P., Sands, W.,A., & Smith, S.L. (2004). A Comparative Case Study of Roche Vaults Performed by Elite Male Gymnasts. *Technique*, August, 6-9.

Čuk, I. & Karacsony, I. (2004). *Vault, Methods, Ideas, Curiosities, History*. Ljubljana: ŠTD Sangvinčki.

Dolenec, A., Čuk, I., Karacsony, I., Bricelj, A. & Čoh, M. (2006). Runway characteristics of vault in women gymnastics. *Kalokagathia*, 44(3-4), 127-136.

Ferkolj, M. (2010). A kinematic analysis of the handspring double salto forward tucked on a new style of vaulting table. *Science of Gymnastics Journal* 2(1), 35-48.

FIG (2009a). *Apparatus Norms*. Loussane: FIG.

FIG (2009b). *Code of Points Men Artistic Gymnastics*. Loussane: FIG.

FIG (2009c). *Code of Points Women Artistic Gymnastics*. Loussane: FIG.

Greenwood M., & Newton, J.W. (1996). Direct force measurement of the vault take off in gymnastics. In: ISBS - Conference Proceedings Archive, 14 International Symposium on Biomechanics in Sports, 332-335, Obtained from: <http://w4.ub.uni-konstanz.de/cpa/article/view/2729/2576> on 26.7.2011.

Kavanagh, J.J., & Menz, H.B. (2008). *Accelerometry: A technique for quantifying movement patterns during walking*, *Gait & Posture* 28, 1 – 15.

Keränen, T., Moisio, T., & Linnamo, V. (2007). *Artistic gymnastics vaults vertical take off velocity measured by electromechanical film*. Obtained from: http://www.kihu.jyu.fi/tuotostiedot/julkine_n/2007_ker_artistic_g_10000.pdf on 26.7.2011.

Križaj, D., & Mihevc, I. (2007). Prenosni merilni sistem za merjenje pospeškov [Portable measurement system for measuring accelerations]. *Šport*, 55(4), 58-64.

Močnik, C., & Križaj, D. (2008).

Načrtovanje prenosnega merilnega sistema za merjenje pospeškov [Design of portable data logger system for accelerometer sensors]. *Inf. MIDEEM*, 38(2), 89-93.

Sano S, Ikegami Y, Nunome H, Apriantono, T., & Sakurai, S. (2007). The continuous measurement of the springboard reaction force in gymnastic vaulting.

Journal of Sports Sciences 25(4), 381-391.

Semenov, L.P. (1987). *Opornie prižki [Vault]*. In: Gaverdovskij, J.K., et all. *Gimnastičeskoe mnogobore mužskie vidi*. Moskva: Fiskultura i sport.

Sands W.A., Smith, S.L., & Piacentini T. (2008). *Studying Vault Board Behavior: A Preliminary Look*. Obtained from:

http://www.polhemus.com/?page=motion_case_studies_vault on 26.7.2011.

Veličković, S., Petković, D., & Petković, E. (2011). A case study about differences in characteristics of the run-up approach on the vault between top-class and middle-class gymnasts. *Science of Gymnastics Journal* 3(1), 25-34.

Zeng, H., & Yhao, Y. (2011). Sensing movement: Microsensors for body motion measurement. *Sensors* 11, 638-660.

Žagar, T., & Križaj, D. (2005). Validation of an accelerometer for determination of muscle belly radial displacement. *Med. biol. eng. comput.* 43(1)78-84.

Corresponding author:
Ivan Čuk
Faculty of Sport
University of Ljubljana
Gortanova 22
1000 Slovenia
E-mail: ivan.cuk@fsp.uni-lj.si

THINKING SENSIBLY ABOUT INJURY PREVENTION AND SAFETY

William A. Sands¹, Jeni R. McNeal², Monèm Jemni³ & Gabriella Penitente⁴

¹Monfort Family Human Performance Research Laboratory Kinesiology, Mesa State University, USA

²Department Physical Education, Health, and Recreation
Eastern Washington University, USA

³Sport Science with Professional Football Coaching, University of Greenwich at Medway, UK

⁴Faculty of Health & Wellbeing, Sheffield Hallam University, UK

Original review article

Abstract

In spite of considerable media, educational, conference, and medical attention, gymnastics' most serious problem remains – injury. Programs for injury prevention, recovery, and treatment have been proposed often, implemented haphazardly and have shown little merit with respect to actually reducing injury incidence and rate. The countermeasures involved in injury prevention include a variety of tools ranging from apparatus specifications to the attitudes of administrators, coaches and athletes. Sadly, if any one of the countermeasures is inadequate an injury is a likely result. The relative risks of poorly constructed and implemented safety programs, poor training and a lack of imagination, and simple denial of risk are among the most serious threats to attaining and maintaining reduction of injury incidence and rate. Five questions are proposed as a model for injury prevention and safety involving ideas that have been gathered from both safety and security literature. The ramifications of these questions are discussed and their potential use in identification of countermeasures is postulated.

Keywords: *gymnastics, training, risks.*

INTRODUCTION

Gymnastics' most serious problem has been and remains - injury (Sands, 2000a). Injury is certainly harmful, and all safety programs involve the prevention of unintentional threats of harm. Thus, safety and injury prevention are linked by intentional countermeasures that can be used to prevent a threat of injury, prevent the likelihood of an injury, and reduce the damage caused by an injury. In this paper we would like to focus on the similarities and use some of the ideas that are found in security programs to augment our thinking about safety programs, and a safety culture for gymnastics.

Among the various threats of harm, safety programs and systems are easier to understand and implement than security programs and systems because security involves an “attacker” who is attempting to defeat security measures and thereby cause harm, gain access, lower morale, instill fear, and/or maximize these effects in a population. Safety programs do not involve an opponent who is trying to defeat injury prevention and reduction measures. Safety measures are defeated, or non-existent in some circumstances, and result in harm that may be every bit as devastating as a security breach, but the harm is based on unforeseen

circumstances, failure of imagination, lack of appreciation of the presence and magnitude of risks, and/or simple laziness. Both security and safety involve alarms. Security may involve physical alarms while safety involves alarms of reasoning and imagination. For example, if an athlete is allowed to do X, the risks to the athlete and others may be Y_1 , Y_2 , Y_3 , and so forth. By coupling actions with consequences, both desirable and harmful, we can be prepared to reduce the probability of harm. Too often, people simply ignore risks by taking a “no-news-is-good-news” mentality until something bad happens that results in them finally noticing a problem that had been there - sometimes for years. What we often see was summarized by Gerstein (Gerstein, 2008):

“However, the alarms were ignored by those who had the power to disregard them. Why? How do smart, high-powered people, leaders of global corporations, national institutions, and even nations get it so wrong”, p 1.

That highly ranked and powerfully placed people make mistakes is not surprising in our modern complex world. What is surprising is how often the obvious evidence, clear alarms, missed cautions, and ignored common sense permeate so much of acrobatic sport. All too often risks are ignored until it's too late: “Nevertheless, many high-powered people had remained unconvinced that we were at risk, so nothing was done – until it was too late for anything but damage control” (Gerstein, 2008) p 3. In gymnastics, what are some typical risks that are too often ignored?

1. Pits that are not filled to the top with foam, are too shallow, or not padded properly (Allen, 1985; Finkel, 2001; Isabelle & Jones, 1990; Klaus, 1985; Klaus & Allen, 1990; Sands, Cunningham, Johnson, Meek, & George, 1991a; United States Olympic Committee, 1995; Wettstone, 1979).

2. Mats that are old and have lost both their resiliency and absorbency (Copeland, 1985; Cunningham, 1988; Gatto, Swannell, & Neal, 1992; Gros & Leikov, 1995; Salvo

& Copeland, 1990; Sands, Cunningham, Johnson, Meek, & George, 1988; Sands, Cunningham, Johnson, Meek, & George, 1991b; Shields & Smith, 2009).

3. Apparatus floor cables that are frayed or otherwise damaged (Federation Internationale de Gymnastique, 1989; Geist, 1985; Mills, 1998; Niu, Lu, Xu, Liang, & Li, 2000).

4. Inadequate matting for the nature of the skill being performed (Caine, Cochrane, Caine, & Zemper, 1989; Caine, Lewis, O'Connor, Howe, & Bass, 2001; Caine, 2002a; Caine, 2002b; McNitt-Gray, Yokoi, & Millward, 1993; McNitt-Gray & Yokoi, 1989; McNitt-Gray, Yokoi, & Millward, 1994; Sands et al., 1988; Sands & Drew, 2007; Wilson, Millhouse, Swannell, & Neal, 1986; Wilson, Neal, & Swannell, 1989).

5. Gymnasts that attempt skills that are too advanced for them or sometimes the coach is seduced by the very talented athlete into thinking that the athlete cannot make a serious error (Malmberg, 1985; Moskovitz, 1990; Moskovitz, 1993; Sands, 1990a; Sands, 1990c; Whitlock, 1989a; Whitlock, 1989b).

6. Gymnasts that are not properly conditioned to withstand the stresses and strains of training and competition (Sands, 1985a; Sands, 1990b; Sands, Major, Irvin, Lemons, & Abramowitz, 1991; Sands & McNeal, 1997).

7. Horseplay – all one needs to see dangerous horseplay is to watch gymnastics videos on YouTube™, specifically those that show people performing skills without any visible adult supervision and narrowly missing injury (Russell, Quinney, Hazlett, & Hillis, 1995; Sands, 1990b; Sands, 1993; Sands, 1994a; Sands, 1994b; Sands, 2000b; Sands, Dunlavy, Smith.S.L., Stone, & McNeal, 2006; Sands, Irvin, & Major, 1995; Sands & Major, 1991).

8. Poorly designed apparatuses that do not meet the needs of the gymnast that uses them (Daly, Bass, Finch, & Corral, 1998; Hartfel, Reeves, Munkasy, & Smith, 1991; Kawata & Murayama, 1988; Leglise,

1999; Sands, 1985b; Sands, 2000a; Sands & George, 1988; Sands et al., 2005).

9. Unwarranted and disruptive parental intrusions (Bungum, Wald, & Martin, 2000; High Performance Productions, 1997; Malina, 1986; Malina, 1997; Power & Woolger, 1994; Weiss & Ebbeck, 1996; Weiss & Hayashi, 1995; Whelpley, 1995)

10. Too much confidence in spotting (Boone, 1979; Daly et al., 1998; George, 1988a; Mitchell & Longdon, 1985; Sands, 1996; Sands, 2000a; Whitlock, 1992).

11. Poor spotting skills (Cowan, 1987; George, 1988b; Hage, 1983; Milem, 1990; Mitchell & Longdon, 1990; Whitlock, 1989c)

12. Practicing while fatigued (Kolt, 1992; Petrone & Ricciardelli, 1987; Sands, 1987; Sinyakov, 1984; Vain, 2002).

13. Practicing while injured. (Aldridge, 1987; Caine et al., 1989; Caine, Howe, Ross, & Bergman, 1997; Caine, Lindner, Mandelbaum, & Sands, 1995; Daly et al., 1998; Daly, Bass, & Finch, 2001; Hadjiev, 1991; Steele & White, 1986)

14. Poor understanding of the mechanics of safe skill performance (Sands & Stone, 2006; Stone, Sands, & Stone, 2004).

15. Too many competitions (Issurin, 2008; Issurin, 2010), and the modern international competitive format which does not allow the athlete's personal coach to attend and be on the competitive floor.

16. And, many more.

The length of the litany of items listed above should cause one in acrobatic sports to pause for a moment and realize just how potentially dangerous the activities are. Moreover, so little has actually been done to develop countermeasures for training and performance safety. One of the most important countermeasures is mats (ASTM Designation: F 1162-88 (Reapproved 1999), 2000; ASTM Designation: F 1676-96, 2000; ASTM Designation: F 1931-98, 2000; ASTM Designation: F 381-99, 2000; Copeland, 1985; Copeland, 1990; Copeland, 1999; Jacki, 1977; McNeice, 1981;

McNeice, 1989; Mills, Pain, & Yeadon, 2006; Perez-Soriano et al., 2010; Salvo & Copeland, 1990; Sands et al., 1988; Sands et al., 1991b; Shields & Smith, 2009; Wilson et al., 1986). Mats serve much like a trapeze artist's net. Generally, when all other countermeasures have failed; mats are the final opportunity for protection. As such, mats should receive a great deal more attention than they have. For example, drop tests are still the gold standard for mat testing, the dropping of a known mass onto the mat and measuring accelerations and indentation. Gros and Leikov (Gros & Leikov, 1995) have questioned the effectiveness of mats on feet-first landings, McNeice (McNeice, 1981; McNeice, 1989) has questioned mats relative to material characteristics and impact, and Sands and colleagues (Sands et al., 1988; Sands et al., 1991a; Sands et al., 1991b) have questioned the efficacy of mats and pits depending on where the gymnast lands in a simulated unplanned fall on mats and absorptive characteristics of a foam pit. Some investigators have endeavored to test mats in much the same way as automobile manufacturers test vehicles, but given the expense of an instrumented crash mannequin and the specialized nature of its use, drop weights and other substitutes have been the norm. Moreover, rarely do human impacts with mats gain much attention (Sands et al., 1988; Sands et al., 1991a; Sands et al., 1991b), but when human impacts are investigated the primary approach is on controlled landings on the feet (McNitt-Gray, 1991a; McNitt-Gray, 1991b; McNitt-Gray, 1999; McNitt-Gray & Anderson, 1993; McNitt-Gray et al., 1997; McNitt-Gray, Munkasy, Welch, & Heino, 1994a; McNitt-Gray, Munkasy, Welch, & Heino, 1994b; McNitt-Gray, Requejo, Flashner, & Held, 2004; McNitt-Gray et al., 1993; McNitt-Gray & Yokoi, 1989; McNitt-Gray et al., 1994). The studies performed by McNitt-Gray and colleagues clearly indicate that the gymnast uses various neuromuscular strategies to accommodate descent distance and landing surface. These excellent studies have not been transferred

to the most injurious landings which involve unplanned falls that do not land on the feet.

Inadequate, inappropriate, and self-training are collectively responsible for many injuries and require their own set of countermeasures (Sands, 1987; Sands, 1990a; Sands, 2002). All of these require that those who are highly ranked and powerfully placed in administrative/leadership roles be fully risk-aware, and utterly committed to a safety. This commitment must be present in spite of limited funds, pressure from young people and parents to progress too fast, little experience and knowledge of the risks inherent in an activity, a reckless quest for increased difficulty, and elevating spectacle at the expense of preparation, training, conditioning, fatigue control, facilities, and other factors. Self-training has most recently risen to a level of concern as various examples of "street-acrobatics" (e.g., Parkour) have become popular among youngsters in extreme sports (Johnson, 1985; Lloyd, 2006; Miller & Demoiny, 2008; Patel & Luckstead, 2000; Victorian Injury Surveillance System, 1996).

Spotting, or the act of physically assisting and/or manipulating the athlete's body through space or through the movement, is considered a potent injury countermeasure (Boone, 1979; George, 1988a; George, 1988b; Hage, 1983). When spotting is performed during a planned movement, the task of the spotter is often quite simple and easy to learn and perform. The spotter and the gymnast often perform a sort of spotting choreography with the resulting "juggling" of the athlete's body with little threat of a fall. Unfortunately, during an unplanned fall, spotting is rarely effective. Human reaction and movement time present serious, unavoidable and immutable constraints on how much a human spotter can do to protect a falling gymnast (Daly et al., 1998; Gebauer, 1988; George, 1988b; Sands, 1996; Sands, 2000a). The only experimental work available on spotting was performed by Gebauer in conjunction with a vault accident and resulting litigation. The primary finding

was that there was far too little time for a spotter to impose any meaningful movement or safety maneuver with a falling gymnast. Spotting, while an important aspect of acrobatic sport, is not a panacea.

We are, by nature, not very good at estimating the magnitude of risk. We seem to adjust our ideas of risk based on our personal experiences rather than evidence-based information. "Careful studies show that when we are asked to assess likelihood, we often answer with a subjective assessment of how well the story fits with our expectations: The degree of narrative fit rather than our objective assessment of the actual likelihood determines our ultimate probability judgment" (Gerstein, 2008), p 25. Even expectations of gain and loss influence our decisions about risk. "The primary – and non-intuitive – finding is that people are risk-averse when anticipating a gain but risk-seeking when anticipating a loss. In other words, when people feel confident that they are going to be successful in some venture or investment, they will forgo the uncertain possibility of additional gains in exchange for greater certainty. On the other hand, if they anticipate a loss, they will often double down their bets in the hope of getting even" (Gerstein, 2008), p 30. Risk taking and risk aversion are also modified by whether we choose to take the risk or if we have no control. "People underestimate risks they willingly take and overestimate risks in situations they can't control. When people voluntarily take a risk, they tend to underestimate it. When they have no choice but to take the risk, they tend to overestimate it" (Schneier, 2006), p 27. To make a final effort at amplifying how we do at estimating risk, note that: "More people are killed every year by pigs than by sharks, which shows you how good we are at evaluating risk" (Schneier, 2006), p 29. Gymnastics often displays these propensities in coaching and athlete choices to perform a skill "one most time," attempt skills that are beyond the gymnast's safe capacity, and replace sound progressions with apparatus-related countermeasures –

like foam pits (Finkel, 2001; Malmberg, 1985; Sands, 1990a; Sands, 1990b; Sands, Cunningham, Johnson, Meek, & George, 1991; Whitlock, 1989).

Given that our intuitions and judgments are often wildly off or misplaced, how can a coach, administrator, parent, and athlete do a better job of managing risk? Common sense tells us that. "Threats determine the risks, and the risks determine the countermeasures" (Schneier, 2006), p 21. Moreover, no safety program is foolproof, but neither are all safety programs equal. There are poor practices and excellent practices. Each is largely context dependent, but within each context there are ways to arrive at a tentatively "best" decision. In any litigious society, it is incumbent on everyone in gymnastics, from those who make the rules to those who follow the rules, to those who evaluate the performance by the rules, to be aware of how to implement a safety program and establish a safety culture that permeates all aspects of gymnastics learning and performance.

Five Questions to Design and Implement a Safety Program and Culture

The problem of safety implementation can be tidily collected in five questions or ideas. The answers to these questions are sometimes complex and sometimes obvious, but careful consideration of each layer of questions and answers – no matter how tentative - will help prepare gymnastics administrators and coaches to develop and implement a safety culture and program.

There are a few prerequisites to a safety program. First, there has to be an institutional commitment. "Without an institutional recognition of risk, an emphasis on safety is unlikely, and in the absence of a focus on safety, it is impossible to achieve it" (Gerstein, 2008), p 103. In short, safety has to be on the minds of every person every day, and every moment, particularly those in leadership positions. Much of the implementation of a safety culture is the

recognition of threats or hazards that are to be avoided and a vigilance of observation and reasoning in evaluating every individual circumstance for the presence of risk. "Without a rigorous, multilevel process for trapping hazards, the likelihood of an accident at some point is 100 percent." (Gerstein, 2008), p 124.

Question 1. What assets are you trying to protect?

"Assets" may sound a little cold when thinking about your primary asset which is the athlete. However, the term is still appropriate because there are often needs to protect non-athlete assets in order to protect the athlete later. For example, the coach may need to protect parents from themselves because some like to try the skill that their youngster is working on. For example, injuries to parents have occurred due to the parent jumping into a foam pit. While such acts are often seen as fun; and gymnasts land in pits all the time; a weaker, older, heavier, less skilled, and perhaps overzealous parent trying the same skill can result in injury because the parent has never been instructed and practiced in how to land in a pit. An injured parent can turn suddenly into a litigious adversary because of the injury and regardless of how well his/her youngster is doing in gymnastics. Another asset is a coach. There are some spotting techniques that are more helpful than others. Moreover, coaches have often sprained thumbs and torn their biceps tendon when trying to catch a falling gymnast.

There are other assets to be protected such as: college or national team scholarships, your gym's reputation, your exposure to litigation, the competitiveness of your athletes, and the long-term career prospects of the athletes. At the very first step you need to determine precisely what it is you're trying to protect. Although inherent in coaching, one of the most difficult aspects of the first question is that the specific risks that a given athlete may

face throughout a workout may change wildly and you will need to have a clear designation in mind about who/what you're trying to protect at any moment. Failure to consider this step results in haphazard and ill-designed safety programs and poorly implemented countermeasures. Moreover, understanding what you're protecting helps focus time, resources, and attitudes more precisely.

Question 2. What are the risks to these assets?

In general terms, the primary risk for the gymnast is an unexpected fall to a non-forgiving surface, in a precarious posture, and from a height, swing, or run that is sufficient to result in high forces that lead to injury. The items listed above can occur singly or in combination with each item interacting with all the others. Teasing apart the interactions to focus more precisely on the actual risks or threats can be difficult. Moreover, there are other risks. One of the risks of gymnastics training is learning bad skill habits that intrude and interfere with later skill learning. Gymnastics injuries are not always acute; some injuries manifest themselves only after weeks or months of training and are called "overuse" injuries (Aldridge, 1987; Caine et al., 1997; Chan, Aldridge, Maffulli, & Davies, 1991; De Smet, Claessens, Lefevre, & Beunen, 1994; Steele & White, 1986). Coaches know that there are specific risks involved with each skill, and they establish and implement countermeasures to avoid and/or reduce these risks.

"The first rule of preventing and coping with accidents is understanding the risks you face. This is a multipart requirement and involves grasping the statistical risks – what's likely to happen each time you are exposed to the hazard, as well as the cumulative risk that arises over multiple exposures. Just as important, you must come to emotional terms with the fundamental difference between the probability of a mishap and the

consequences should an adverse event come to pass" (Gerstein, 2008), p 241. Risks can be acute, cumulative, probable, improbable, foreseen, unforeseen, and so forth.

Risks do not have to be physical. Psychological stress and accumulated stress can also harm the gymnast. Much like post traumatic stress disorder (PTSD) the perceptions of a gymnast's abilities and his/her reactions to an injury can be as or more devastating to the gymnast as a physical injury. The combination of a high pressure competitive atmosphere, an inherently dangerous sport with regard to falling, and the fragile nature of young peoples' views of themselves and of others can conspire to destroy a promising career simply because the gymnast cannot cope (Chase, Magyar, & Drake, 2005; Feigley, 1987; Feigley, 1989; Gould, Petlichkoff, Prentice, & Tedeschi, 2000; Henschen, 1985; Kolt, Hume, Smith, & Williams, 2004; Kolt & Kirkby, 1994; Lindner, Caine, & Johns, 1991; Rotella, Ogilvie, & Perrin, 1993; Sachs, Sitler, & Schwille, 1993; Sanders, 1990). An "injury prone" personality has yet to be determined, but the coach needs to perform moment-to-moment assessments of the moods, focus, attitudes, and alertness of each athlete as he/she practices and performs (Ford, Eklund, & Gordon, 2000; Kolt & Kirkby, 1996; Leddy, Lambert, & Ogles, 1994; Sands, 1990b; Sands et al., 1991; Sands & McNeal, 1997; Shiraishi, 1999)

Finally, there are threats to the gymnast that come from sources outside of gymnastics. These hazards can be "trash talk" from other athletes, inappropriate expectations, pressures from the media, and overzealous parental involvement, among others (Bungum et al., 2000; Duda & Hom, 1993; Ryan, 1994; Weiss & Ebbeck, 1996; Weiss & Hayashi, 1995).

The risks of gymnastics skills are often obvious, but there are certainly historical incidences where gymnasts were harmed by slipping sideways from the

apparatus to land in an unmatted area, an off-hand comment that ruins an athlete's psychological preparation, apparatuses that were not set properly – even at an Olympic Games (Swift, 2000), and many others. The problem of determining skill readiness for a gymnast's first attempt at a new skill has been discussed previously and involves a gauntlet of questions that each coaching decision must pass through before allowing the gymnast to try the new skill (Sands, 1990a).

Question 3. How well does the safety solution mitigate the risks?

There are several general means of reducing risk in gymnastics. The various methods fall into several categories:

1. Safety in layers. Safety in depth means that there are multiple countermeasures that the gymnast must pass through before he/she is irretrievable from an injury circumstance. For example, a gymnast must be highly conditioned for the skill in question (first layer), the gymnast may be hand spotted by a skillful coach (second layer), and the skill may be performed over or into a foam pit (third layer). In assessing the three layers of protection listed above you should determine the weakest link because a safety failure is most likely to occur there. If the gymnast is not fit enough (strong, flexible, fast, non-fatigued, lean, and alert) then the conditioning item could be the source of an injury. If the hand spot is missed, or there is a miscommunication between athlete and spotter such that the spotter interferes with the gymnast and the gymnast and/or the spotter are injured then the spotting layer is likely a source of elevated risk. If the pit is incompletely filled with foam and in an unfluffed condition. If the pit fails too then the gymnast's likelihood of injury becomes almost a certainty. Safety in layers is extremely important in preventing and reducing the magnitude of an injury. The more layers of protection used the less likely the gymnast will experience failure in

all of the various countermeasures. James Reason illustrates this idea in his "Swiss Cheese" model. The basic idea is that each slice of cheese is a countermeasure. The hole(s) in the cheese slices represent failure of the particular countermeasure. In order, for a complete failure to occur the "holes" of the Swiss cheese must line up. As long as all the slices fail to line up as a single hole completely through all, then the injury is prevented and a countermeasure worked to prevent a problem (Gerstein, 2008), p 128.

2. Social Redundancy. Risks can be mitigated by something called "social redundancy," which can be thought of in two ways: multiple people are responsible for a decision, or you use people as direct countermeasures (e.g., multiple spotters to catch the gymnast). Social redundancy, as used with multiple spotters, proceeds from the hope that if the gymnast does something unexpected that at least one of the spotters will be able to prevent an injurious fall. Whenever a gymnast is going to attempt something for the first time, or when a gymnast may not be up to the task, the decision to continue should be spread across more than one person. This kind of social redundancy helps the coach and athlete increase their certainty about the skill in question. Coaches should work as teams in assessing a gymnast's readiness for any particular skill, routine, conditioning exercise, and so forth. The athletes themselves can also provide a part of social redundancy by indicating whether they think they're ready for a new skill or whether they think their teammate is ready. Gymnasts are often excellent sources of information and too often encouraged to remain uninvolved.

3. Avoid Denial. One of the most important means of implementing a safety culture and program is to avoid denial. Denial is a state of ignoring risks that are clearly present and possible while hiding behind the idea that nothing serious has ever happened before so therefore no one can

possibly be seriously injured. The absence of proof is not proof of absence. You don't want to make safety decisions based on an absence of evidence. Safety programs require vigilant observation of people, equipment, facility, conditioning, athlete status, and coaching practices. It is very important that you pay attention to weak signals and early warnings that an injury may be lurking (Sands, 1984). Moreover, don't wait until you have absolute proof of a safety threat before acting to impose logical and effective countermeasures (Gerstein, 2008).

Determining the risks actually faced by your asset(s) can be tricky and may rely on best guesses and abundant past experience. These are all acceptable as long as they result in a safer environment. One must be careful to avoid something called "safety theatre" in which safety measures are implemented but don't actually increase safety. In gymnastics one of the most overrated safety procedures is hand spotting (Sands, 1996). Human spotters do quite well when the falls are planned and the spotting and gymnastics skills are sort of a pre-rehearsed choreography. Catching an unplanned fall is a completely different story. Human beings are constrained by reaction times, information processing times, response times, and movement times. The segmented times listed in the previous sentence often conspire by accumulation to keep a skilled coach from catching the falling gymnast in spite of his/her best intentions (Sands, 1990a; Woodson, Tillman, & Tillman, 1992).

Question 4. What other risks does the safety solution cause?

"Unanticipated consequences," "collateral damage" and "revenge effects" have entered the modern lexicon referring to those things that happen as a consequence of some changes to a system that results in some things that were not predicted and largely unknown to the system designer. Revenge effects usually refer to the

unanticipated results of unruly technology, so we will use "unanticipated consequences" (UC) for our purposes (Tenner, 1996). There are always UCs when something is changed in a dynamic system. For example, it is a common practice to place a large stack of skill cushions on the landing side of the vault table in order to practice various aspects of the vault with reduced fear and consequences of uncontrolled landings on a lower surface. The UC in this case is that the number of these types of mats in a gym is usually limited and by placing a large number of these mats behind the vault table, the other events may have to go without resulting in greater risk exposure at the other events or activities.

Following the introduction of foam pits to gymnastics, they were considered extraordinarily effective learning tools (Malmberg, 1978) and people were filling these large holes with many different types of loose foam pieces. There were many UCs that arose from these new loose foam pits. For example, in spite of the inherent softness of these pits, people could still get injured in them and athletes had to practice landing in the pits safely. Falls onto the head were not as safe as one might at first expect. Moreover, if an athlete is injured in a pit, one quickly finds that removing the gymnast from the pit presents some extreme obstacles to keeping the gymnast immobile while rescuers attempt to reach the injured gymnast (Finkel, 2001; United States Olympic Committee, 1995).

Everyone in gymnastics should consider what consequences are likely to follow all actions undertaken. Anticipating consequences of actions is one of the major hallmarks of an experienced coach. Often, the experts in any activity seem to almost magically anticipate problems before they become unsolvable and thereby protect the athlete while ensuring progress. Although safety is the current topic, a strongly related aspect of coaching is the selection and order of the content of skill progressions. Most

experienced coaches and teachers know that some skills have to be learned prior to other skills, and that some skills interfere with the learning of some future skills (Del Rey, 1989; Hickson, 1980; Lee, Swanson, & Hall, 1991; Magill & Hall, 1990). Experience in this realm is truly priceless and often nearly invisible to an observer.

Question 5. What costs and trade-offs does the safety solution impose?

Safety solutions are often expensive simply because they require more of something. In gymnastics, the most common safety equipment is found in soft matting. Mats tend to be expensive and have limited life spans. However, an appropriate mat can make all the difference in reducing risk to manageable proportions. Second to mats are foam pits, either solid or filled with foam blocks of various sizes. Foam pits can be built in the ground or above ground and can cost thousands of dollars. After mats and pits the costs of safety equipment can be seen in conditioning equipment, modern apparatuses, traffic control items, barriers that separate people such that collisions are avoided, and many others. Often trade-offs are made between new equipment, particularly mats, and old equipment that no longer meets the deceleration requirements needed to safely stop or catch a falling gymnast.

Trade-offs may sound somewhat confusing, but there are always trade-offs in gymnastics training safety. The very nature of the sport requires that the gymnast push his/her performance envelope ever higher by virtue of skill difficulty. Gymnasts may begin learning with multiple layers of protection (i.e., safety in layers), but ultimately the gymnast seeks to perform the skill with only a mat as the single countermeasure to prevent injury.

Trade-offs are often seen in the struggle between impatience and solid skill performance. While everyone would like to

learn fast, there can be problems with learning too fast and thereby missing some of the important skills and means of escaping a mistake that naturally occur when progressions are long and painstaking. Dividing the skill into easier to learn smaller parts usually results in greater technical mastery, but the trade-off is time. The part-whole method of teaching/learning has been around probably as long as there have been skills to teach. Foam pits provide a good example of a potential trade-off by allowing gymnasts to do many repetitions with less fear of falling, but the foam pit doesn't ensure that the skills that lead to the target skill are well learned.

A serious trade-off seen in gymnastics training is the trade-off between difficulty of a skill and consistency of the skill. Usually the more difficult skill is less consistent than an easier skill. However, the Code of Points often forces the coach and gymnast into a precarious position of encouraging greater difficulty at the expense of consistency and safety (International Gymnastics Federation, 2000; Sands, 2000a).

CONCLUSION

In order to think sensibly about injury prevention and safety, you need to consider what you're trying to protect, what risks are the most prevalent, which countermeasures are most effective, the unintended consequences of the countermeasures, and finally the trade-offs that go hand-in-hand with implementation of a safety program and culture. Daniel Bernoulli once wrote that "fear of harm ought to be proportional not merely to the gravity of the harm, but also the probability of the event." This statement nicely summarizes a sensible safety program and culture. You must strike a balance between invoking countermeasures against the most egregious injuries and injuries that have the greatest likelihood of happening. In making these kinds of decisions it may be helpful to look to Aristotle who set out the patterns of inference (e.g., reasoning): deduction and

induction. However, he also described a third type of inference called apagoge. This third method of inference has also been called abduction or retroduction. The idea goes something like this: Some surprising thing happens or is observed. The thing that happens is explicable as a matter of course if something else were true. Hence, there is reason to believe that the something else is true. Turning the idea around, if you consider apparent risks and perhaps some trivial or rare risks as being potential threats to the safety of the gymnast, then you are obliged to invoke countermeasures against these "something else" threats. In a sense, it is using a hunch, a rule of thumb, and perhaps intuition guided by reason. Err on the side of being too protective, of invoking multiple countermeasures, of recognizing weak signals or small threats as potentially cumulative to become big threats, and do not be fooled by denial.

REFERENCES

- Aldridge, M. J. (1987). Overuse injuries of the distal radial growth epiphysis. T. B. Hoshizaki, J. H. Salmela, & B. Petiot *Diagnostics, treatment and analysis of gymnastic talent* (pp. 25-30). Montreal, Canada: Sport Psyche Editions.
- Allen, K. (1985). Above-ground training pits. G. George. *USGF gymnastics safety manual* (pp. 58-61). Indianapolis, IN: U.S. Gymnastics Federation.
- ASTM Designation: F 1162-88 (Reapproved 1999). (2000). Standard specification for pole vault landing pits. *ASTM Annual Book of ASTM Standards 2000* (pp. 368-370). West Conshocken, PA: ASTM.
- ASTM Designation: F 1676-96. (2000). Standard specifications for basic tumbling mats. *ASTM Annual Book of ASTM Standards 2000* (pp. 590-592). West Conshocken, PA: ASTM.
- ASTM Designation: F 1931-98. (2000). Standard test method for characterization of gymnastic landing mats and floor exercise surfaces. *ASTM Annual Book of ASTM Standards 2000* (pp. 808-811). West Conshocken, PA: ASTM.
- ASTM Designation: F 381-99. (2000). Standard safety specification for components, assembly, use, and labeling of consumer trampolines. *ASTM Annual Book of ASTM Standards 2000* (pp. 5-9). West Conshocken, PA: ASTM.
- Boone, W. T. (1979). *Better gymnastics - how to spot the performer*. Mountain View, CA: World Publications.
- Bungum, T. J., Wald, J., & Martin, S. (2000). Parental motivation for supporting their children's involvement in a private gymnastic program. *Medicine and Science in Sports and Exercise*, 32(5), S95.
- Caine, D., Cochrane, B., Caine, C., & Zemper, E. (1989). An epidemiologic investigation of injuries affecting young competitive female gymnasts. *American Journal of Sports Medicine*, 17(6), 811-820.
- Caine, D., Howe, W., Ross, W., & Bergman, G. (1997). Does repetitive physical loading inhibit radial growth in female gymnasts? *Clinical Journal of Sport Medicine*, 7(4), 302-308.
- Caine, D., Lewis, R., O'Connor, P., Howe, W., & Bass, S. (2001). Does gymnastics training inhibit growth of females. *Clinical Journal of Sport Medicine*, 11, 260-270.
- Caine, D. J. (2002a). Injury and growth. W. A. Sands, D. J. Caine, & J. Borms. *Scientific Aspects of Women's Gymnastics* (pp. 46-71). Basel, Switzerland: Karger.
- Caine, D. J. (2002b). Injury epidemiology. W. A. Sands, D. J. Caine, & J. Borms *Scientific Aspects of Women's Gymnastics* (pp. 72-109). Basel, Switzerland: Karger.
- Caine, D. J., Lindner, K. J., Mandelbaum, B. R., & Sands, W. A. (1995). *Gymnastics. Epidemiology of Sports Injuries*. Champaign, IL: Human Kinetics.
- Chan, D., Aldridge, M. J., Maffulli, N., & Davies, A. M. (1991). Chronic stress injuries of the elbow in young gymnasts. *The British Journal of Radiology*, 64, 1113-1118.
- Chase, M. A., Magyar, M. T., &

Drake, B. M. (2005). Fear of injury in gymnastics: self-efficacy and psychological strategies to keep on tumbling. *Journal of Sports Sciences*, 23(5), 465-475.

Copeland, D. (1985). Gymnastics mats. G. George *USGF gymnastics safety manual* (pp. 43-52). Indianapolis, IN: U.S. Gymnastics Federation.

Copeland, D. (1990). Mats for cheerleading activities. G. S. George. *AACCA Cheerleading Safety Manual* (pp. 34-37). Memphis, TN: The UCA Publications Department.

Copeland, D. (1999). Part 5. Gymnastics Mats in Diving Programs. J. L. Gabriel *U.S. Diving safety training manual* (2nd ed., pp. 75-78). Indianapolis, IN: United States Diving, Inc.

Cowan, R. (1987). A review of spotting trends. *Gymnastics Safety Update*, 2(3), 3.

Cunningham, S. J. (1988). *A model of gymnastic landing mats and pits and human subject response*. Unpublished doctoral dissertation, University of Utah.

Daly, R., Bass, S., Finch, C., & Corral, A.-M. (1998). *Balancing gymnastics and injury risk*. Victoria, Canada: Deakin University School of Movement.

Daly, R. M., Bass, S. L., & Finch, C. F. (2001). Balancing the risk of injury to gymnasts: how effective are the counter measures? *British Journal of Sports Medicine*, 35, 8-20.

De Smet, L., Claessens, A., Lefevre, J., & Beunen, G. (1994). Gymnast wrist: an epidemiologic survey of ulnar variance and stress changes of the radial physis in elite female gymnasts. *American Journal of Sports Medicine*, 22(6), 846-850.

Del Rey, P. (1989). Training and contextual interference effects on memory and transfer. *Research Quarterly for Exercise and Sport*, 60(4), 342-347.

Duda, J. L., & Hom, H. L. (1993). Interdependencies between the perceived and self-reported goal orientations of young athletes and their parents. *Pediatric Exercise Science*, 5, 234-241.

Federation Internationale de Gymnastique. (1989). *Apparatus norms*.

Zurich, Switzerland: Federation Internationale de Gymnastique.

Feigley, D. A. (1987). Preventing psychological burnout. J. H. Salmela, B. Petiot, & T. B. Hoshizaki. *Psychological nurturing and guidance of gymnastic talent* (pp. 230-247). Montreal, Canada: Sport Psyche Editions.

Feigley, D. A. (1989). Coping with fear. *Technique*, 9(2), 4-9.

Finkel, C. B. (2001). Removal of a gymnast with suspected cervical injuries from a soft foam pit. *Technique*, 21(9), 5-7, 11-15, 39.

Ford, I. W., Eklund, R. C., & Gordon, S. (2000). An examination of psychosocial variables moderating the relationship between life stress and injury time-loss among athletes of a high standard. *Journal of Sports Sciences*, 18, 301-312.

Gatto, F., Swannell, P., & Neal, R. (1992). A force-indentation relationship for gymnastic mats. *Journal of Biomechanical Engineering*, 114, 338-345.

Gebauer, D. (1988). Simulation of the biomechanical conditions of a paraplegia accident in gymnastic exercises. *SOSCOC New Horizons of Human Movement - Abstracts I* (p. 291). Seoul, Korea: SOSCOC.

Geist, J. (1985). Gymnastics apparatus. G. S. George. *USGF Gymnastics Safety Manual* (pp. 35-42). Indianapolis, IN: U.S. Gymnastics Federation.

George, G. S. (1988a). Reflections on spotting. *Gymnastics Safety Update*, 3(3), 2.

George, G. S. (1988b). Spotting - a sacred trust. *Gymnastics Safety Update*, 3(1), 1-2.

Gerstein, M. (2008). *Flirting with disaster*. New York, NY: Union Square Press.

Gould, D., Petlichkoff, L. M., Prentice, B., & Tedeschi, F. (2000). Psychology of sports injuries. *Sports Science Exchange Roundtable*, 11(2), 1-4.

Gros, H. J., & Leikov, H. (1995). Safety considerations for gymnastics landing mats. A. Barabas, & G. Fabian. *Biomechanics in Sports XII*. (pp. 194-197). Budapest, Hungary: International Society of

Biomechanics in Sports, ITC Plantin.

Hadjiev, N. (1991). Gymnastics chronic trauma: Methodological aspects. *FIG Scientific/Medical Symposium Proceedings, 1*, 5-7.

Hage, P. (1983). Gymnastics injuries due to poor spotting. *The Physician and Sportsmedicine, 11*(5), 26.

Hartfel, M. A., Reeves, M. E., Munkasy, B. A., & Smith, S. L. (1991). Pilot study of a new apparatus cover. *USGF Sport Science Congress Proceedings, 1*(1), 48-50.

Henschen, K. (1985). Psychological readiness. G. George. *USGF gymnastics safety manual* (pp. 72-74). Indianapolis, IN: U.S. Gymnastics Federation.

Hickson, R. C. (1980). Interference of strength development by simultaneously training for strength and endurance. *European Journal of Applied Physiology and Occupational Physiology, 45*, 255-263.

High Performance Productions. (1997). *Parent's guide to trampoline safety*. High Performance Productions.

International Gymnastics Federation. (2000). *2000-2004 Code of Points Men's Artistic Gymnastics* (2001 Edition ed.). Indianapolis, IN: International Gymnastics Federation.

Isabelle, E., & Jones, T. (1990). Solid-foam training pits. G. S. George. *USGF gymnastics safety manual* (pp. 52-56). Indianapolis, IN: U.S. Gymnastics Federation.

Issurin, V. (2008). *Block periodization: Breakthrough in sport training*. Muskegon, MI, USA: Ultimate Athlete Concepts.

Issurin, V. B. (2010). New horizons for the methodology and physiology of training periodization. *Sports Medicine, 40*(3), 109-206.

Jacki, M. (1977). Selection, installation, care, and maintenance of gymnasium mats. E. Wettstone. *Gymnastics safety manual* (pp. 17-18). University Park, PA: Penn State University Press.

Johnson, C. (1985). A philosophy of safety awareness. G. S. George. *USGF Gymnastics Safety Manual* (pp. 1-3).

Indianapolis, IN: U.S. Gymnastics Federation.

Kawata, K., & Murayama, Y. (1988). Safety measures for Senoh Corporation gymnastic apparatus. *World Gymnastics, 4-5*(3), 37-38.

Klaus, B. (1985). In-ground training pits. G. George. *USGF gymnastics safety manual* (pp. 56-58). Indianapolis, IN: U.S. Gymnastics Federation.

Klaus, B., & Allen, K. (1990). Loose-foam training pits. G. S. George *USGF gymnastics safety manual*. (pp. 50-51). Indianapolis, IN: U.S. Gymnastics Federation.

Kolt, G. (1992). Gymnastics injuries - why they occur. *Gymnastics Safety Update, 7*(3), 1-2.

Kolt, G., & Kirkby, R. (1996). Injury in Australian female competitive gymnasts: A psychological perspective. *Australian Journal of Physiotherapy, 42*(2), 121-126.

Kolt, G. S., Hume, P. A., Smith, P., & Williams, M. M. (2004). Effects of a stress management program on injury and stress of competitive gymnasts. *Perceptual and Motor Skills, 99*(1), 195-207.

Kolt, G. S., & Kirkby, R. J. (1994). Injury, anxiety, and mood in competitive gymnasts. *Perceptual and Motor Skills, 78*, 955-962.

Leddy, M. H., Lambert, M. J., & Ogles, B. M. (1994). Psychological consequences of athletic injury among high-level competitors. *Research Quarterly for Exercise and Sport, 65*(4), 347-354.

Lee, T. D., Swanson, L. R., & Hall, A. L. (1991). What is repeated in a repetition? Effects of practice conditions on motor skill acquisition. *Physical Therapy, 71*(2), 150-156.

Leglise, M. (1999). Gymnastics equipment and injuries. M. Leglise. *Symposium Medico-Technique* (pp. 7-16). Lyss, Switzerland: International Gymnastics Federation.

Lindner, K. J., Caine, D. J., & Johns, D. P. (1991). Withdrawal predictors among physical and performance characteristics of female competitive gymnasts. *Journal of Sports Sciences, 9*, 259-272.

- Lloyd, C. (2006). Extreme sports--ignore the safety advice at your peril. *Emergency Medicine Journal*, 23(11), 887-888.
- Magill, R. A., & Hall, K. G. (1990). A review of the contextual interference effect in motor skill acquisition. *Human Movement Science*, 9, 241-289.
- Malina, R. M. (1986). Readiness for competitive youth sport. M. R. Weiss, & D. Gould. *Sport for children and youths* (10 ed., pp. 45-50). Champaign, IL: Human Kinetics.
- Malina, R. M. (1997). Talent identification and selection in sport. *Spotlight on Youth Sports*, 20(1), 1-3.
- Malmberg, E. (1978). Science, innovation, and gymnastics in the USSR. *International Gymnast*, 20(2), 63.
- Malmberg, E. (1985). Performer readiness. G. George *USGF gymnastics safety manual* (pp. 69-72). Indianapolis, IN: U.S. Gymnastics Federation.
- McNeice, G. (1981). *Impact tests of gymnastics mats, Final report, Prepared for Spieth-Anderson Company Limited, Orillia, Ontario*. Waterloo, Ontario, Canada: University of Waterloo Research Institute.
- McNeice, G. (1989). *Improved design of gymnastic mats, prepared for Spieth Anderson International, Inc. Orillia, Ontario*. Waterloo, Ontario, Canada: University of Waterloo.
- McNitt-Gray, J. L. (1991a). Kinematics and impulse characteristics of drop landings from three heights. *International Journal of Sport Biomechanics*, 7(2), 201-224.
- McNitt-Gray, J. L. (1991b). The influence of joint flexion, impact velocity, rotation, and surface characteristics on the forces and torques experienced during gymnastics landings. *FIG Scientific/Medical Symposium Proceedings*, 1(1), 17-18.
- McNitt-Gray, J. L. (1999). Neuromuscular control and performance of landings in gymnastics. M. Leglise. *Symposium Medico-Technique* (pp. 55-66). Lyss, Switzerland: International Gymnastics Federation.
- McNitt-Gray, J. L., & Anderson, D. D. (1993). Balance control strategies of collegiate divers during the take-off phase of platform dives. R. Malina, & J. L. Gabriel. *U.S. Diving Sport Science Seminar 1993 Proceedings* (pp. 121-128). Indianapolis, IN: U.S. Diving Publications.
- McNitt-Gray, J. L., Irvine, D. M. E., Munkasy, A., Eagly, J., Smith, T., & Chen, Y. T. (1997). *Mechanics and motor control of gymnastics take-offs and landings*. Report to USOC Sport Science Division.
- McNitt-Gray, J. L., Munkasy, B. A., Welch, M., & Heino, J. (1994a). External reaction forces experienced by the lower extremities during the take-off and landing of tumbling skills. *Technique*, 14(9), 10-16.
- McNitt-Gray, J. L., Munkasy, B. A., Welch, M., & Heino, J. (1994b). Kinetics of successful and unsuccessful gymnastics landings. *Technique*, 14, 27-30.
- McNitt-Gray, J. L., Requejo, P. S., Flashner, H., & Held, L. (2004). Modeling the musculoskeletal behavior of gymnasts during landings on gymnastics mats. M. Hubbard, R. D. Metha, & J. M. Pallis. *The Engineering of Sport 5* (pp. 402-408). Sheffield, UK: International Sports Engineering Association.
- McNitt-Gray, J. L., Yokio, T., & Millward, C. (1993). Landing strategy adjustments made by female gymnasts in response to drop height and mat composition. *Journal of Applied Biomechanics*, 9(3), 173-190.
- McNitt-Gray, J. L., & Yokoi, T. (1989). The effect of impact velocity and mat characteristics on landing strategies of gymnasts. *Proceedings 1st IOC World Congress on Sport Sciences, Oct. 28 - Nov. 3, 1*, 305-306.
- McNitt-Gray, J. L., Yokoi, T., & Millward, C. (1994). Landing strategies used by gymnasts on different surfaces. *Journal of Applied Biomechanics*, 10(3), 237-252.
- Milem, D. J. (1990). Spotting belts. G. S. George *USGF gymnastics safety manual* (pp. 47-49). Indianapolis, IN: U.S. Gymnastics Federation.
- Miller, J. R., & Demoiny, S. G. (2008). Parkour: a new extreme sport and a

case study. *Journal of Foot and Ankle Surgery*, 47(1), 63-65.

Mills, C., Pain, M. T. G., & Yeadon, M. R. (2006). Modeling viscoelastic gymnastics landing mat during impact. *Journal of Applied Biomechanics*, 22(2), 103-111.

Mills, S. H. (1998). Indirect measurement of forces on the gymnastics rings. H. J. Riehle, & M. M. Vieten. *ISBS '98 XVI International symposium on biomechanics in sports* (I ed., pp. 192-195). Konstanz, Germany: UVK - Universitätsverlag.

Mitchell, R., & Longdon, P. (1985). Spotting and gymnastic safety. G. George *USGF gymnastics safety manual* (pp. 63-67). Indianapolis, IN: U.S. Gymnastics Federation.

Mitchell, R., & Longdon, P. (1990). Spotting and gymnastics safety. G. S. George *USGF gymnastics safety manual* (pp. 57-62). Indianapolis, IN: U.S. Gymnastics Federation.

Moskovitz, D. (1990). The role of safety certification in the professional development program. *Gymnastics Safety Update*, 5(4), 1-2.

Moskovitz, D. (1993). Am I responsible for that?! *Gymnastics Safety Update*, 8(2), 1.

Niu, J., Lu, X., Xu, G., Liang, B., & Li, L. (2000). Study on gymnastics ring movements using force measuring system. Y. Hong, & D. P. Johns. *Proceedings of XVIII International Symposium on Biomechanics in Sports* (I ed., pp. 321-324). Hong Kong, China: The Chinese University of Hong Kong, International Society for Biomechanics in Sports.

Patel, D. R., & Luckstead, E. F. (2000). Sport participation, risk taking, and health risk behaviors. *Adolescent Medicine*, 11(1), 141-155.

Perez-Soriano, P., Llana-Belloch, S., Morey-Klapsing, G., Perez-Turpin, J. A., Cortell-Tormo, J. M., & van den Tillaar, R. (2010). Effects of mat characteristics on plantar pressure patterns and perceived mat properties during landing in gymnastics. *Sports Biomechanics*, 9(4), 245-257.

Pettrone, F. A., & Ricciardelli, E. (1987). Gymnastic injuries: The Virginia experience 1982-1983. *American Journal of Sports Medicine*, 15(1), 59-62.

Power, T. G., & Woolger, C. (1994). Parenting practices and age-group swimming: a correlational study. *Research Quarterly for Exercise and Sport*, 65(1), 59-66.

Rotella, R. J., Ogilvie, B. C., & Perrin, D. H. (1993). The malingering athlete: psychological considerations. D. Pargman. *Psychological bases of sport injuries* (pp. 85-97). Morgantown, WV: Fitness Information Technology, Inc.

Russell, K. W., Quinney, H. A., Hazlett, C. B., & Hillis, D. (1995). Knee muscle strength in elite male gymnasts. *The Journal of Orthopaedic and Sports Physical Therapy*, 22(1), 10-17.

Ryan, R. (1994). *The mental health of female college student-athletes: Research and interventions on a university campus*. Austin, TX: A Report to the Hogg Foundation, The RGK Foundation.

Sachs, M. L., Sitler, R. M., & Schulle, G. (1993). Assessing and monitoring injuries and psychological characteristics in intercollegiate athletes: a counseling/prediction model. D. Pargman. *Psychological bases of sport injuries* (pp. 71-84). Morgantown, WV: Fitness Information Technology, Inc.

Salvo, J., & Copeland, D. (1990). Gymnastics mats. G. S. George *USGF Gymnastics Safety Manual* (pp. 40-44). Indianapolis, IN: United States Gymnastics Federation.

Sanders, D. J. (1990). The effects of adolescent growth in dancers and gymnasts. *New Zealand Journal of Sports Medicine*, 18(2), 22-24.

Sands, B. (1984). *Coaching women's gymnastics*. Champaign, IL: Human Kinetics.

Sands, B. (1985a). Conditioning for gymnastics: A dilemma. *Technique*, 5(3), 4-7.

Sands, B. (1985b). Gymnastics safety equipment 1. Personal equipment. G. George. *USGF gymnastics safety manual*

(pp. 53-54). Indianapolis, IN: U.S. Gymnastics Federation.

Sands, B. (1987). The edge of the envelope. *Gymnastics Safety Update*, 2(3), 2-3.

Sands, W., Cunningham, S. J., Johnson, S. C., Meek, S. G., & George, G. S. (1988). Levels of protection gymnastics safety equipment: A summary for coaches. *Technique*, 8(3-4), 22-25.

Sands, W. A. (1990a). Determining skill readiness. *Technique*, 10(3), 24-27.

Sands, W. A. (1990b). Physical readiness. G. S. George. *USGF gymnastics safety manual* (pp. 63-68). Indianapolis, IN: U.S. Gymnastics Federation.

Sands, W. A. (1990c). Physical readiness. G. S. George. *AACCA Cheerleading Safety Manual* (pp. 51-56). Memphis, TN: UCA Publications Department.

Sands, W. A. (1993). Strength symmetry assessments of 8-12 year old female gymnasts. W. A. Sands. *USA Gymnastics 1993 National Congress - Sport Science Symposium* (pp. 29-34). Indianapolis, IN: USA Gymnastics.

Sands, W. A. (1994a). Physical abilities profiles - 1993 national TOPs testing. S. Whitlock. *1994 Congress, USA Gymnastics Proceedings Book* (pp. 29-34). Indianapolis, IN: USA Gymnastics.

Sands, W. A. (1994b). Physical abilities profiles - 1993 National TOPs testing. *Technique*, 14(8), 15-20.

Sands, W. A. (1996). How effective is rescue spotting? *Technique*, 16(9), 14-17.

Sands, W. A. (2000a). Injury prevention in women's gymnastics. *Sports Medicine*, 30(5), 359-373.

Sands, W. A. (2000b). Physiological aspects of gymnastics. B. G. Bardy, T. Pozzo, P. Nouillot, N. Tordi, P. Delemarche, C. Ferrand, Y. L. Ziart, D. Hauw, J. Aubert, M. Loquet, A. Durny, & J. F. Robin *Actes des 25^{mes} Journées Internationales d'Etude de l'A.F.R.A.G.A.* (pp. 68-71). Université de Rennes, Rennes, France: L'Association Française de Recherche en Activités Gymniques et Acrobatiques (A.F.R.A.G.A.).

Sands, W. A. (2002). *Gymnastics Risk Management: Safety Handbook 2002 Edition*. Indianapolis, IN: USA Gymnastics.

Sands, W. A., Cunningham, S. J., Johnson, S. C., Meek, S. G., & George, G. S. (1991a). Deceleration characteristics of foam pit landing areas in gymnastics. *FIG Scientific/Medical Symposium Proceedings*, 1(1), 19-23.

Sands, W. A., Cunningham, S. J., Johnson, S. C., Meek, S. G., & George, G. S. (1991b). Deceleration characteristics of gymnastics landing mats. *FIG Scientific/Medical Symposium Proceedings*, 1(1), 24-27.

Sands, W. A., & Drew, G. (2007). A case study of trampoline throw-in mats & peak accelerations. *Technique*, 27(1), 10-11.

Sands, W. A., Dunlavy, J. K., Smith, S. L., Stone, M. H., & McNeal, J. R. (2006). Understanding and training the Maltese. *Technique*, 26(5), 6-9.

Sands, W. A., & George, G. S. (1988). Somersault trajectory differences: Foam block versus coil spring floor. *Technique*, 8(1), 8-9.

Sands, W. A., Irvin, R. C., & Major, J. A. (1995). Women's gymnastics: The time course of fitness acquisition. A 1-year study. *Journal of Strength and Conditioning Research*, 9(2), 110-115.

Sands, W. A., Jemni, M., Stone, M. H., McNeal, J. R., Smith, S. L., & Piacentini, T. (2005). Kinematics of vault board behaviors - a preliminary comparison. *Sème Journées Internationales de L'AFRAGA*. Leeds University, Leeds, UK: Association Française Recherche en Activités Gymniques et Acrobatiques.

Sands, W. A., Major, J., Irvin, R., Lemons, P., & Abramowitz, R. (1991). Conditioning programs, U.S. elite gymnastics. *Technique*, 11(4), 12-14.

Sands, W. A., & Major, J. A. (1991). The time course of fitness acquisition in women's gymnastics. *FIG Scientific/Medical Symposium Proceedings*, 1, 9-13.

Sands, W. A., & McNeal, J. R. (1997). A minimalist approach to conditioning for women's gymnastics. S. Whitlock. *1997*

USA Gymnastics Congress Proceedings Book (pp. 78-80). Indianapolis, IN: USA Gymnastics.

Sands, W. A., & Stone, M. H. (2006). Monitoring the elite athlete. *Olympic Coach, 17*(3), 4-12.

Schneier, B. (2006). *Beyond fear*. New York, NY: Springer Science & Business.

Shields, B. J., & Smith, G. A. (2009). The potential for brain injury on selected surfaces used by cheerleaders. *Journal of Athletic Training, 44*(6), 595-602.

Shiraishi, Y. (1999). Psychological considerations on safety equipment and learning/teaching apparatus. M. Leglise. *Symposium Medico-Technique* (pp. 93-104). Lyss, Switzerland: International Gymnastics Federation.

Sinyakov, A. F. (1984). Restoration of work capacity of gymnasts. *Soviet Sports Review, 19*(3), 105-109.

Steele, V. A., & White, J. A. (1986). Injury prediction in female gymnasts. *British Journal of Sports Medicine, 20*(1), 31-33.

Stone, M. H., Sands, W. A., & Stone, M. E. (2004). The downfall of sports science in the United States. *Strength and Conditioning Journal, 26*(2), 72-75.

Swift, E. M. (2000). Fumbling exercises. *Sports Illustrated, 93*(13), 70-71.

Tenner, E. (1996). *Why things bite back*. New York, NY: Random House.

United States Olympic Committee. (1995). Gymnastics pit removal for cervical injuries - Video Tape. *U.S. Olympic Committee Publications, Colorado Springs, CO, 7:17, DUB 10/19/00, 1*.

Vain, A. (2002). Criteria for preventing overtraining of the musculoskeletal system of gymnasts. *Biology of Sport, 19*(4), 329-345.

Victorian Injury Surveillance System. (1996). Childhood injuries from playground equipment. *Hazard, 29*, 1-16.

Weiss, M. R., & Ebbeck, V. (1996). Self-esteem and perceptions of competence in youth sports: Theory, research and enhancement strategies. O. Bar-Or. *The child and adolescent athlete* (pp. 364-382).

Oxford, England: Blackwell Science, Ltd.

Weiss, M. R., & Hayashi, C. T. (1995). All in the family: Parent-child influences in competitive youth gymnastics. *Pediatric Exercise Science, 7*, 36-48.

Wettstone, G. (1979). The use of gymnastic pits in teaching gymnastics skills. *International Gymnast Magazine, 21*, 75.

Whelpley, R. (1995). Get your parents with the program. *Safety Update, 10*(3), 2-3.

Whitlock, S. (1989a). Increasing the level of safety awareness in your gym. *Gymnastics Safety Update, 4*(3), 1-5.

Whitlock, S. (1989b). When is a gymnast ready? *Gymnastics Safety Update, 4*(4), 2-4.

Whitlock, S. (1989c). When is spotting appropriate? *Gymnastics Safety Update, 4*(2), 5-6.

Whitlock, S. (1992). Hand spotting. *Gymnastics Safety Update, 7*(3), 3-4.

Wilson, B. D., Millhouse, D., Swannell, P., & Neal, R. (1986). *A biomechanical investigation of gymnastic take-off and landing surfaces*. Canberra, ACT, Australia: Technical Report - Applied Sports Research Program, Australian Sports Commission.

Wilson, B. D., Neal, R. J., & Swannell, P. D. (1989). The response of gymnastic sports floors to dynamic loading. *The Australian Journal of Science and Medicine in Sport, 21*(1), 14-19.

Woodson, W. E., Tillman, B., & Tillman, P. (1992). *Human factors design handbook*. New York, NY: McGraw-Hill.

Corresponding author:

Wm A. Sands, PhD, FACSM, C-ARS, NR/WEMT

Director - Monfort Family Human Performance Research Laboratory
Colorado Mesa University

Kinesiology

1100 North Avenue, Grand Junction
CO 81501

wsands@coloradomesa.edu

ULNAR VARIANCE AND ITS RELATED FACTORS IN GYMNASTS: A REVIEW

Luísa Amaral¹, Albrecht Claessens², José Ferreirinha^{3,4} & Paulo Santos^{5,6}

¹Health Sciences School, University of Fernando Pessoa, Portugal

²Department of Biomedical Kinesiology, Katholieke Universiteit Leuven, Belgium

³University of Trás-os-Montes and Alto Douro, Portugal

⁴Research Centre for Sport, Health and Human Development (CIDESD), Portugal

⁵Faculty of Sport, University of Porto, Portugal

⁶Centre of Research, Education, Innovation and Intervention in Sport (CIFI2D), Portugal

Original review article

Abstract

Ulnar variance is the relative length of ulna in relation to the radius. This morphological variation in the distal epiphyseal structures may lead to symptoms or pathologic changes to the wrist joint. In order to evaluate and quantify distal radioulnar length discrepancy, different imaging techniques are used, depending on the individual's maturity. The purpose of this review is to summarize the current literature on this subject and to describe ulnar variance trends, taking into account its association with biological and/or training precursors. Our study analyzes the incidence of positive, neutral and negative ulnar variance between gymnasts and the general population (both immature and mature), seeking to identify possible wrist injury risk factors, which usually influence the gymnasts' health and performance.

Keywords: *gymnastics, morphology, wrist, injury.*

INTRODUCTION

Artistic Gymnastics (AG) demands a high level of performance which requires that gymnasts begin their practice and specialization at very early ages, before bone maturation (Caine, DiFiori & Maffulli, 2006; DiFiori, Caine & Malina, 2006; DiFiori & Mandelbaum, 1996).

Based on results from biomechanical studies of the physis, the vulnerability for growth plate injuries is higher during the adolescent growth spurt (Caine et al., 2006; Daly, Bass & Finch, 2001; DiFiori et al., 2006; DiFiori, Puffer, Aish & Dorey, 2002a). During this period, the injury risk may increase due to the weakness in the transition area of the cartilage's hypertrophic cell junction and the area of the calcification matrix in the metaphyseal side of the growth plate (Caine, Roy, Singer & Broekhoff, 1992;

DiFiori & Mandelbaum, 1996). One of the specific training characteristics in AG is the alternation of support between upper and lower limbs, with the upper extremities often used for weight-bearing therefore, receiving high impacts in both the elbow and wrist (Caine, 2003; Claessens et al., 2003; Daly et al., 2001; DiFiori et al., 2006; DiFiori et al., 2002a). So, with the early beginning of specialized training the growth plate in gymnasts' wrists becomes a potential place for injuries (DiFiori et al., 2006; DiFiori et al., 2002a). These different types of stress, which include axial compression, rotation and distraction forces (Webb & Rettig, 2008), may exceed twice the body weight of the gymnast (Koh, Grabiner & Weiker, 1992). Events such as pommel horse, floor exercise, vault, and balance beam include many skills which

expose the wrist joint to repeated loads with relatively large static and dynamic forces (DiFiori et al., 2006). Many of gymnastics' skills cause an extraordinary stress on the distal growth plates of radius and ulna, on the carpal bones of the hand and on many ligaments that stabilize these structures (Dwek, Cardoso & Chung, 2009).

Actually, gymnasts of both genders have frequent wrist pain (DiFiori et al., 2006), which may influence their performance in training and/or competition, leading to the reduction of the number of repetitions in training sessions and lost training days (Caine et al., 1992; DiFiori et al., 2006; Roy, Caine & Singer, 1985). Several authors (Caine, Lindner, Mandelbaum & Sands, 1996; De Smet, Claessens, Lefevre & Beunen, 1994; Roy et al., 1985) relate stress changes of the distal radius to epiphyseal traumas and supports that in AG (particularly female athletes) the repetitive loads in the immature wrist may result (besides wrist pain) in partial interruption of distal radial growth plate and subsequent development of positive ulnar variance (UV) during bone maturation. Alternatively, it has been suggested that the positive UV observed on gymnasts may result from individual characteristics (Claessens, Lefevre, Beunen, De Smet & Veer, 1996), and in part genetically influenced (Beunen, Malina, Claessens, Lefevre & Thomis, 1999; Cerezal et al., 2002).

The aim of this article is to review the literature concerning the UV phenomenon showing the related factors, the main research information on the subject, as well as its connection to the practice of AG. Knowledge about the different factors that may exacerbate the UV and predispose some gymnasts to wrist pain might help to prevent injuries and improve gymnastics performance.

METHODS

Data sources and searches

The following databases were searched: Medline journals from 1969 to

January (week 1) 2011. The combinations of key words entered with Boolean operators were: ulnar variance 'AND' gymnast 'AND' mature (n=3, excluded 2); ulnar variance 'AND' 'NOT' gymnast 'AND' mature (n=3, excluded 2); ulnar variance 'AND' gymnast 'AND' immature (n=8, excluded 4); ulnar variance 'AND' 'NOT' gymnast 'AND' immature (n=89, excluded 88). Additionally the combinations ulnar variance 'AND' gymnast wrist 'OR' wrist pain, anthropometric characteristics, hand strength, dominance, handedness, laterality 'OR' measurement, were used. The total number of studies found about ulnar variance was 644. All other references were obtained through citations (from bibliographies of the retrieved articles). If any additional study-specific components or parameters were reported, they were also listed.

Selection of studies

Inclusion criteria were: 1) Primary sources published in English peer-reviewed journals that included data related to UV values and measurement in mature or immature humans; 2) males and females; 3) subjects without clinically diagnosed osteoarticular or rheumatologic pathology and not submitted to any surgery; and 4) intrinsic and extrinsic factors related to UV.

Exclusion criteria were: 1) review articles or secondary sources to eliminate potential bias; 2) not full text; 3) case reports; 4) books; 5) articles unrelated; 6) alterations only in radial growth; and 7) injury/peripheral neuromuscular pathologies or fractures.

Our review of the literature exposed 8 cross-sectional studies and 3 cohort studies (one retrospective, one prospective and one mixed-prospective) with relevant data on immature gymnasts, and 2 cross-sectional studies and 1 prospective cohort on mature gymnasts.

Related to the general population, 11 cross-sectional studies were revealed, 3 prospective cohort studies and no randomised controlled study was found. Studies described UV values, method of

data collection, sample and some factors or conditions which may influence UV such as anthropometric and training characteristics.

Each article was reviewed looking for information about UV and its relation with biological and training characteristics. Through these data we seek to increase the knowledge about the effects and risks of gymnastics practice on the alterations of distal growth plates from radius and ulna and to know if there was compromised development. The data from the gymnastics' population was related to the general population.

RESULTS

The concept of 'ulnar variance'

The concept of UV or the radioulnar index, refer to the relative difference in length between radius and ulna and have been well described since the beginning of the 20th century (Schuurman, Maas, Dijkstra & Kauer, 2001). Caine, Howe, Ross & Bergman (1997) preferred a different terminology using the term 'ulna-radial length difference'.

Cited by Schuurman et al. (2001), Hultén introduced in 1928 the expressions of variation 'ulnar plus' and 'ulnar minus' in order to describe the length of the ulna relative to the length of the radius. When the length of the distal ulna exceeds the length of distal radius by 1 mm or more, UV is considered positive or labelled as 'ulnar overgrowth', and it is negative when the length of the distal ulna is less than the length of distal radius by 1 mm or more (Hafner, Poznanski & Donovan, 1989; Palmer, Glisson & Werner, 1982). When the relative length of the distal radius and ulna differ by less than 1 mm, UV is labelled as 'neutral' (De Smet, 1994; DiFiori et al., 2006). The variance is independent of the length of the ulnar styloid process (Cerezal et al., 2002).

The length of the ulna relative to the length of the radius (expressed by UV) is not constant but varies in the course of life (De Smet, 1994) and may be affected by daily activities involving repetitive forearm

movements (Cerezal et al., 2002; Sönmez, Turaclar, Tas & Sabanciogullari, 2002). Several authors (Freedman, Edwards, Willems & Meals, 1998; Schuurman et al., 2001; Sönmez et al., 2002) mention differences in length between radius and ulna during static (unloaded) and dynamic (loaded) evaluation leading to towards a significant increase in positive UV. UV affects the forces' distribution across the wrist (Webb & Rettig, 2008), and for this reason can be an important feature of wrist disorders or 'pathological' wrist (De Smet, 1994), since the percentage of load suffered by the distal epiphysis of the radius increases with a shorter ulna (DiFiori et al., 2002a). The load on the neutral UV wrist is normally shared between radius and ulna in approximately an 80:20 ratio (Anderson, Read & Steinweg, 1998) and this ratio changes with the increase or decrease of UV values. In a biomechanical evaluation concerning force distribution on the wrist joint, Bu, Patterson, Morris, Yang & Viegas (2006) verified that the load distribution between ulna and radius in the positive UV wrists was, on average, 69% and 31%, respectively. In the negative UV wrists the load distribution ranged on average between 94% on the radius and 6% on the ulna.

Several pathological conditions are correlated with negative UV, namely the carpal instability, ulnar subluxation of the carpals, avascular necrosis of the scaphoid and scapholunate dissociation (De Smet, 1994). Nishiwaki, Nakamura, Nakao, Nagura & Toyama (2005) have reinforced the possibility that higher values of negative UV are associated with increased pressure over the distal radio-ulnar joint and a greater probability of degenerative alterations. In this context, it seems reasonable that wrists with high levels of negative UV present a higher prevalence of pain and abnormal radiographic signs in the distal radial growth plate (DiFiori et al., 2002a). On the other hand, the positive UV in gymnasts may increase the ulnar carpal loading (Palmer et al., 1982), or contribute to the ulnar impact syndrome, degenerative injuries, cartilaginous wear of carpal bones, rupture

of the triangular fibrocartilage complex and osteomalacia of the ulnar carpals (Anderson et al., 1998; Cerezal et al., 2002; De Smet, 1994; Yoshioka et al., 2007).

Other deformities caused by the repetition of micro-traumas in the epiphysis before skeletal maturity may lead to the premature closure of the growth plate (De Smet, 1994) and stress injuries of the physis may lead to permanent sequelae, even in asymptomatic individuals (Chang et al., 1995). The radial and palmar inclination of the distal articular radial surface transmits a vertical compression force into the palmar-ulnar sector, creating high compression and premature closure of the palmar-ulnar part of the physis (De Smet, 1994). Similar changes take place in the 'Madelung-like deformity', an irregularity in the development of the wrist, characterized by anatomical changes in the radius, ulna and carpal bones. Radiographic findings reveal increased dorsal and radial bowing of the distal radius, triangular-shaped carpus, exaggerated volar and ulnar tilt of the distal articular radial surface, positive UV (Arora & Chung, 2006; Brooks, 2001; Zebala, Manske & Goldfarb, 2007) and even ulnopalmar subluxation of the carpus (Brooks, 2001; De Smet, 1994).

In the context of AG, De Smet, Claessens & Fabry (1993) have referred to this situation as the 'gymnast wrist', or 'Madelung-like deformity'. In a case study involving a female gymnast, Brooks (2001) used this latter expression due to its similar appearance to the relatively uncommon developmental malformation (2% of the general population), although it was a case involving traumatic etiology. Dwek et al. (2009) recommended that, the term 'gymnast wrist', usually associated with a chronic physeal trauma, should be enlarged to include nonphyseal osseous, ligamentous and osteochondral injuries.

Measurement of ulnar variance: technical concerns

Since the epiphyses of children are not yet completely ossified, the techniques to measure UV have to be different from those

used in adults, requiring a specific method demanding different criteria of measurements (De Smet, 1994; Hafner et al., 1989; Palmer et al., 1982).

The evaluation of UV in immature wrists is done through radiological measures of the distance from the most proximal point of the ulnar metaphysis to the most proximal point of the radial metaphysis (PRPR) and of the distance from the most distal point of the ulnar metaphysis to the most distal point of the radial metaphysis (DIDI), according to Hafner's method (Hafner et al., 1989). In order to minimize measurement errors, it is possible to draw a medial parallel line to the ulna axis and delineate two perpendicular lines, one touching the most proximal point and the other the most distal point of the distal ulnar metaphysis, as well as the two lines corresponding to the same points in the radial metaphysis (Claessens et al., 1996; Hafner et al., 1989).

Concerning the evaluation of mature wrists, there are several published methods of measurement which are equally reliable: 1) the 'Project-a-line' technique; 2) the Concentric Circles method and modifications (Palmer's method); and 3) the 'Perpendicular'- method (Mann, Wilson & Gilula, 1992).

The 'Project-a-line' technique consists in drawing a solid line from the ulnar side of the articular surface to the distal radius, measuring the distance between the line and the carpal surface of the ulna (Keats & Sstrom, 2001; Mann et al., 1992).

The evaluation of mature wrists by Palmer's method is done through an over positioning of a concentric semi-circles model in the x-ray identifying the circle which most approximates the concavity of the distal sclerotic line of the radius. The distance from this line to the cortical rim of the caput ulna is the measurement used to determine the UV (Keats & Sstrom, 2001; Mann et al., 1992; Palmer et al., 1982).

In the 'Perpendicular'- method, a line parallel to the long axis of the radius is drawn and a second line which passes through the ulnar notch and perpendicular to

the first line. The distance between this second line and the ulna's head is defined as UV (Keats & Sstrom, 2001; Mann et al., 1992; Sönmez et al., 2002).

According to Schuurman et al. (2001), Palmer's method is considered to be simple and reliable, however, errors may occur when the pattern model is placed over an imprecise curvature of the distal extremity of the radius. He considers that this method may be perfected with an electronic digitizer connected to a personal computer. The predominance of positive UV was observed using the concentric circles method, although negative when using the digitizer (Schuurman et al., 2001). Steyers and Blair (1989) have compared the referred methods to measure UV, concluding that all were highly reliable, although the 'Perpendicular'- method was most consistent for both inter and intra-observer reliability.

Ulnar variance in reference populations and gymnasts

Ulnar variance in immature samples

An overview of UV results in immature reference and gymnasts populations is given in Table 1.

With the exception of the study of Chang et al. (1995) on Chinese boys and girls, in which the 'Perpendicular'- method was used to determine the ulnar variance measurements, in all other studies the method of Hafner et al. (1989) was used so that results from the different studies can be compared.

As demonstrated by the data gathered by Hafner et al. (1989) on American boys and girls, ranging in age from 2 to 15 years, the UV is on average negative. With increasing age UV becomes somewhat more negative, ranging from -2.1 to -2.3 mm for PRPR and from -2.3 to -2.8 mm for DIDI. In Chinese boys and girls, Chang et al. (1995) found a mean negative value of -0.05 mm as measured by the 'Perpendicular'-method.

Comparing the results gathered on gymnasts, it can be demonstrated that a wide range of mean UV results is observed.

For PRPR the mean values ranged from -2.2 to +0.50 mm for Portuguese female gymnasts (Amaral, Claessens, Ferreirinha & Santos, 2011) and international World-top female gymnasts (Claessens et al., 1996) respectively. For DIDI, the mean values range from -1.4 to -4.9 mm for international World level female gymnasts (Claessens et al., 1996) and nonelite Flemish female gymnasts (Claessens, Moreau & Hochstenbach, 1998) respectively. When compared with the reference samples, it can be stated that despite the prevalence of negative UV values in immature gymnasts, there are several reports showing greater incidence of relative and absolute positive UV in the gymnasts' samples. However, a closer look at the results shows that these more positive UV values are within the normal range for their age, but at the upper end of the scale, as already demonstrated by Claessens et al. (1996) in a sample of international World level female gymnasts.

Since the values of UV in immature gymnasts are typically negative, probably they have a higher predisposition to an increased load on the radius' growth plate which may influence its development.

Ulnar variance in mature samples

An overview of UV results in mature reference and gymnastics populations is given in Table 2.

Compared to the immature data much more data on mature reference populations are at hand, whereas only a few data sets on mature gymnasts are gathered. Because different techniques are used to measure the UV, comparison of results is not always possible. However, in general all studies performed on mature gymnasts demonstrated a positive mean value for UV, varying from +1.28 to +2.82 mm, respectively for male collegiate nonelite gymnasts and for male collegiate champions (Mandelbaum, Bartolozzi, Davis, Teurlings & Bragonier, 1989).

Data on mature reference populations show, on average, mostly negative and neutral UV values (Ertem, Kekilli, Karakoç & Yologlu, 2009; Freedman et al., 1998;

Schuind, Linscheid, An & Chao, 1992; Unver, Gocen, Sen, Gunal & Karatosun, 2004; Yeh, Beredjikian, Katz, Steinberg & Bozentka, 2001), although some researchs describe small mean positive values (Chang et al., 1995; Chen & Wang, 2008; Jung, Baek, Kim, Lee & Chung, 2001; Sönmez et al., 2002; Yoshioka et al., 2007).

Ulnar variance in gymnasts versus control subjects: statistically controlled studies

An overview of UV results in gymnasts statistically compared to control subjects is given in Table 3.

Except for the study by Claessens, Lefevre, Philippaerts, Thomis & Beunen (1997) in which no statistical difference was observed in UV between two groups of female gymnasts, elite compared to recreational gymnasts, in all other studies a significant more positive UV was shown in the groups of gymnasts compared to the control groups. It has been proposed by several authors that the repetitive stress experienced by the skeletally immature wrist during gymnastics training, especially in the young female elite gymnasts, may lead to the development of wrist pain, partial arrest of the distal radial growth plate, and the subsequent development of positive ulnar variance. Thus, this proposal suggests a dose-response relationship involving the closure of the radial growth plate, caused by the gymnastics training load which results in a positive ulnar variance. This line of reasoning is largely based on 'patients' or 'case'-reports, meaning individuals who present themselves to a clinic with wrist pain, and on cross-sectional studies in which a relatively small number of both nonelite and elite gymnasts were studied.

Although, on average, a positive ulnar variance in most studies could be observed, contradictory results and controversial conclusions were made. Also, due to the small sample sizes and selective recruitment, the subjects under study were not necessarily representative of the elite gymnastics population. Also, most of the studies were set up as a cross-sectional

design and as such, these designs do not allow establishing a cause-effect relationship. Well-controlled longitudinal studies, in which elite gymnasts are followed for several years, are needed, in which the dose-response relationship between gymnastics training and ulnar variance can be studied in a more effective way. To our knowledge there are only a few longitudinal studies of UV in young gymnasts.

Different trends have been noted in the development of UV in two cohort studies of skeletally immature gymnasts (Claessens et al., 1997; DiFiori, Puffer & Dorey, 2001). In a study by Claessens et al. (1997) in which 36 female gymnasts, aged 6 to 14 years, were annually followed for four or five seasons, with a total of 158 observations, a negative UV was observed that became more pronounced with increasing age, the mean UV varied from -3.4 to -6.5 mm. This finding was unexpected given that UV ordinarily becomes somewhat more positive with age in immature (unfused) wrists as demonstrated by the cross-sectional data of Hafner et al. (1989). In contrast, DiFiori et al. (2001) observed that a mean negative UV at baseline became significantly more positive than age-appropriate normative values in 28 male and female gymnasts, aged 5-16 years, during a three year follow-up (DiFiori et al., 2006). More longitudinal and intervention studies are needed to unravel the complex UV phenomenon before more exclusive interpretations can be made.

Factors related with ulnar variance

In order to structure this review with as much consistency as possible, the ulnar variance-related factors were selected based on the relevance given by the literature on this specific matter, which considers intrinsic and extrinsic factors.

As intrinsic factors were considered: a) chronological age and even more importantly the skeletal age due to the relation to the bone morphology; b) morphological and body composition

characteristics (weight, height, BMI, % fat, fat-free mass) because differences in these values can be associated to a different in load and biomechanical characteristics of the impacts; c) handgrip strength because UV has a dynamic character and change with the kind of handgrip; d) hypermobility because certain positions of the wrist joint and forearm (pronation/supination, ulnar/radial deviation) modify the UV (more positive or negative), increasing the UV.

As extrinsic consider were observed: a) training, characterized by hours spent in the activity, which supposedly, besides increase the predisposition of the gymnasts to injury, represent a pool of overhead for all the years of practice; b) the laterality / rotational direction, because most gymnasts use more one side, which consequently suffer more impacts.

Gender, Chronological age and maturation

Age and gender data related to UV in immature and mature reference samples, is given in Table 4.

It is expected that gender and age could influence wrist bone morphology. Several authors failed to find a significant relationship between UV measurements and gender in immature and mature reference populations (Freedman et al., 1998; Hafner et al., 1989; Schuind et al., 1992), even when comparing the two extremes of their range: -3.8 to +2.3 mm in males and -4.2 to 1.6 mm in females (Schuind et al., (1992). Also in more recent studies (Chen & Wang, 2008; Yoshioka et al., 2007) no significant differences in UV according to gender was observed.

However, in contrast to these results, Jung et al. (2001) reported that UV was significantly different when related to gender in a mature population; females exhibited a more positive UV than males (ranging from -2.28 to +4.68 mm and from -2.08 to +3.64 mm, respectively). Similar results were found by other authors (Nakamura, Tanaka, Imaeda & Miura, 1991) with UV ranging from -0.14 mm for males to +0.77 mm for females.

It was observed that all reported data concerning the relationship between UV and both gender and age within the general population are from studies carried out on American and Asiatic samples. Studies on European samples could not be found. Therefore, ethnographic-related factors can possibly explain some UV differences (Jung et al., 2001; Schuind et al., 1992; Yoshioka et al., 2007).

Concerning the relationship between UV and age, in our opinion it is important to analyze the relationship between UV and the gymnast's maturational status instead of chronological age, in order to define the type of association between UV and skeletal age. In this context, it is important to analyze separately the studies where UV is related to chronological age, in contrast to studies where UV is related to skeletal age, in both mature and immature subjects, in the general population and gymnast's samples.

We would like to point out that the evaluation of UV behavior with increasing age (both chronological and skeletal) and the observation of possible changes in a specific age group, would eventually enable the creation of normative values that would allow to predict the cause-effect from extrinsic factors, such as the effect of training in gymnastics.

Studies relating UV and chronological age – gymnasts. Many authors (Beunen et al., 1999; Claessens et al., 1996; De Smet et al., 1994; DiFiori et al., 2002a; DiFiori, Puffer, Mandelbaum & Dorey, 1997) couldn't find a relationship between chronological age and UV in immature gymnasts. In contrast, Dwek et al. (2009) observed a significant trend from a negative towards a more positive UV with advancing age. On the other hand, Claessens et al. (1997) find negative UV values which became more pronounced with advancing age in a longitudinal study performed on female gymnasts.

Studies relating UV and skeletal age – gymnasts. Through the study of skeletal maturation in each bone, Beunen et al.

(1999) postulated a non-association between positive UV and advanced maturity status of the radius or the advanced fusion of the epiphyseal-diaphyseal junction. Claessens et al. (2003) didn't find a significant relation between UV and skeletal age. Meanwhile, a significant positive association between UV and skeletal maturity was reported by Amaral et al. (2011) ($r = 0.38$; $p \leq 0.05$ for DIDI) and by Claessens et al. (1996) ($r = 0.16$ for DIDI; $r = 0.22$ for PRPR), with the latter considering that mature female gymnasts have a greater risk of developing positive UV. However, the correlations between somatic and maturational characteristics with UV were rather low and almost the same for both variance measures (PRPR and DIDI).

Studies on general populations. In mature populations, some authors have reported no significant UV change with increasing chronological age (Chen & Wang, 2008; Freedman et al., 1998; Schuind et al., 1992; Yoshioka et al., 2007). On the other hand, for immature subjects, Hafner et al. (1989) observed that the ranges of both UV measures increase significantly with age.

Therefore, there is a need to standardize UV values in chronological and skeletal age categories in the immature general population in order to be able to observe the normal evolution of the ulna/radius lengths, excluding the effect of weight-bearing in this joint. This is the best way to find out if, in fact, gymnastics skills can cause load injuries and subsequent arrest of radial growth plates, leading to a positive UV.

The relationship between ulnar variance and biological parameters in gymnastics samples can be observed in Table 5.

Anthropometric characteristics

No significant relationships between UV and normative somatic parameters, such as height and weight, have been observed. This lack of relationship can possibly be explained by the fact that in the normal

population, the upper limbs were not used in 'normal' daily activities similar to gymnastics, therefore, do not present significant values of UV modifications.

Unlike most other sports, gymnasts require the use of the wrists as weight-bearing joints, receiving impact loads. Supposedly, heavier gymnasts are more likely to be injured due to the high forces absorbed by the musculoskeletal system (Emery, 2003), so gymnasts with excessive body weight may present greater risk of overload and overuse injuries.

De Smet et al. (1994), Claessens et al. (2003) and Amaral et al. (2011) have all observed significant positive associations between UV and both height and weight in female gymnasts, despite the fact that DiFiori et al. (1997) couldn't find a relationship between these variables.

Other variables of body composition are likely to influence the UV in gymnasts, such as percentage of body fat, fat-free mass and muscular mass. There are potential alterations in the distal physis of the radius in low level gymnasts, especially those who have high percentage of body fat, which may present a more pronounced UV (Caine et al., 1992; O'Connor, Lewis & Boyd, 1996). According to Claessens et al. (1996), high level gymnasts (participants in the world-championships), who are taller, heavier and with a higher muscular mass, tend to present more positive UV. These authors defend the concept that gymnasts who have higher mechanical load on the wrists, have a greater predisposition to develop positive UV, although only few studies support these assumption.

Concerning fat-free mass, Amaral et al. (2011) observed a rather low, but significant correlation ($r = 0.48$) with DIDI, while Claessens et al. (1996) found no significant association between UV and variables related with fat development.

Nevertheless, it cannot be concluded per se that weight and/or height or even other somatic components may contribute to changes in UV, regardless of training and genetic characteristics. It is necessary to know the UV from each gymnast at the

beginning of his sport activity and throughout his career, analyzing UV both independently and simultaneously in relation with other variables.

Dominance / Laterality

According to several authors, the positive UV observed in gymnasts is a consequence of the excessive physical loading on the wrist, being predictable that the dominant hand presents higher positive UV, because it suffers heavier load (Claessens et al., 1998).

However, the concept of dominance and laterality is not unanimous. In the study of Claessens et al. (1998) on 36 female gymnasts of the Flemish region of Belgium, aged 8 - 14 years, dominance was determined by the rotational direction considering the first hand of support when performing a cartwheel. No significant differences were observed in UV between the dominant (mean PRPR = -1.3 mm) and non-dominant wrists (mean PRPR = -1.2 mm) measured by the method of Hafner et al. (1989), suggesting an absence of relationship between the rotational direction and UV. However, one has to take into consideration the fact that gymnasts, when performing a cartwheel to a particular side, do not necessarily perform all other support rotational movements in the same direction. For this reason, it is difficult to state that the load supported in either left or right wrists is the cause of a modification in UV, without first accurately quantifying all wrist weight-bearing results from training.

Regarding laterality, Claessens et al. (1998) found a small but significant difference between the UV results of the right (mean PRPR = -1.6 mm) and the left (mean PRPR = -0.8 mm) wrist for PRPR, in 36 female immature gymnasts. DiFiori et al. (2002a) did not observe a significant association between hand dominance and UV in a group of 59 male and female nonelite gymnasts (USA). A mean side-to-side difference in UV of 0.7 ± 0.6 mm was found that was not associated with hand dominance of the gymnasts as gathered by a questionnaire. In a group of 33 nonelite

Portuguese female gymnasts, Amaral et al. (2011) found a significant difference between left and right wrists for the PRPR variable (PRPR-L = -1.7 mm / PRPR-R = -2.2 mm), in contrast to a non-significant difference when DIDI was taken as the UV measure, -2.8 mm and -3.1 mm for the left and right wrists respectively. In an adult reference sample (n = 100), Freedman et al. (1998) did not find a significant difference between right and left determined ulnar variance, with mean values of -0.13 mm and -0.29 mm for the left and right sides respectively. However, notable individual variations were observed. An overview of right versus left ulnar variance results is given in Table 6.

Handgrip strength

Ulnar variance is affected by handgrip strength (Sönmez et al., 2002). UV increases significantly with a strong handgrip motion and returns to its original status with cessation of the motion (Cerezal et al., 2002), illustrating the dynamic character of UV (Schuurman et al., 2001). During the handgrip strength motion the radio-ulnar glide is greater for wrists with negative UV (Sönmez et al., 2002) and UV within individuals is not uniformly symmetrical (Freedman et al., 1998).

The magnitude of UV varies considerably with handgrip motion, generally with an amplitude between 1 and 2 mm (Cerezal et al., 2002; Tomaino, 2000), and it has been shown that the small changes in ulnar variance have a direct relationship with the magnitude of load-bearing (Sönmez et al., 2002). Changes in ulnar variance under 1 mm can alter mechanical transfer load characteristics by more than 25% and probably have particular clinical significance in individuals who perform repetitive rotational manoeuvres with load on the wrist, as in sports like gymnastics (Mann et al., 1992; Yoshioka et al., 2007).

In fact, a strong handgrip in pronation results in a significant proximal migration of the radius leading to an increase in UV

(Cerezal et al., 2002; Schuurman et al., 2001; Sönmez et al., 2002).

Performing exercises on high bar, parallel bars, pommel horse and rings, where gymnasts use this kind of grip, increases the probability of ulnar impact. Therefore, if immature gymnasts are predisposed to have a negative UV, and since UV increases significantly with a strong handgrip and pronation, both factors may increase the glide of proximal radius, making the UV more neutral or even positive, decreasing the forces on the radial growth plates and therefore may be beneficial to support the load characteristics of gymnasts training.

Studies about gymnasts involving the relationship between UV and handgrip strength are scarce. In a group of 59 nonelite male and female gymnasts, aged 5 - 16 years, DiFiori et al. (2002a) did not find significant relationship between UV and handgrip strength.

A summary of studies in which the relationship between UV and handgrip strength was investigated is given in Table 7.

Hyper-mobility / Range of motion

Boyle, Witt & Riegger-Krugh (2003) have reported generalized joint laxity as a potential risk factor for a variety of injuries and musculoskeletal complaints. Unver, Gocen, Sen, Gunal & Karatosun (2004) stated that there are few studies about the association between UV and range of motion.

Significant differences were found between UV and different wrist positions (Schuurman et al., 2001) supporting the influence of forearm rotation on UV measures (Jung et al., 2001; Sönmez et al., 2002). Pronation causes an increase of ulna length concerning the distal end of the radius, and supination favours the decrease in the ulna length (Anderson et al., 1998; Cerezal et al., 2002; De Smet, 1994; Sönmez et al., 2002).

To our knowledge, most of the studies investigating the relationship between UV

and mobility of the wrists were done in non-athletic, normal samples (Table 8).

In a gymnastics population, this association was partly investigated in a small group (n = 16) of 16-year-old sub-elite female Flemish gymnasts (Claessens, 2004; Vandebussche, 2002). Significant correlations between UV and some mobility measures were found: hyper-extension of the fingers ($r = +0.65$) and hyper-extension of the elbow ($r = +0.52$). The results of this preliminary study suggest that more flexible gymnasts are at a greater risk for developing positive UV.

Pain

Some authors support the theory that pain represents the first stage of an overuse injury which progressively causes a stress injury in the distal extremity of the radius (growth inhibition), allowing the development of positive UV (DiFiori et al., 2002a; DiFiori, Puffer, Aish & Dorey, 2002b). Others believe that painful wrist syndrome is frequently the result of the ulna's overgrowth (positive UV), caused by biomechanical forces that are inherent to gymnastics activities, affecting negatively the radius distal growth plate (Caine et al., 1992; Roy et al., 1985).

The UV and wrist pain in gymnasts increase proportionally with age and total weekly training hours, but this falls short of a cause-effect relationship (Claessens, 2004; DiFiori et al., 2002a). Although several authors (DiFiori et al., 1997) have not observed substantial association between UV and wrist pain, gymnasts with wrist pain presented more negative ulnar variance than those without wrist pain (DiFiori et al., 2002a).

Table 1. *Cross-sectional and cohort data of ulnar variance measurements in immature reference and gymnasts samples.*

Reference	Sample studied		Mean age (yr)	Type of study Skill / level	UV method ^a	Mean UV (mm)
	N	Gender				
<i>Immature populations</i>						
Hafner et al. (1989)	535	M+F	2-15 (range)	Cross-sectional Reference data (USA)	Hafner (PRPR) (DIDI)	-2.1 / -2.3 (range) -2.3 / -2.8 (range)
Chang et al. (1995)	38	M+F	13.2	Prospective cohort Reference data (China)	Perpendicular	-0.05
<i>Immature gymnasts</i>						
De Smet et al. (1994)	156	F	15.9	Cross-sectional World-top / international	Hafner (PRPR) (DIDI)	+0.49 -1.43
Chang et al. (1995)	176	M+F	13.1	Cross-sectional Chinese opera students	Perpendicular	+0.07
Claessens et al. (1996)	156	F	15.9	Cross-sectional World-top / international	Hafner (PRPR) (DIDI)	+0.5 -1.4
Claessens et al. (1997)	36	F	6-14 (range)	Mixed-prospective Nonelite (Flemish/Belgium)	Hafner (DIDI)	-3.4 / -6.5 (range)
DiFiori et al. (1997)	44	M+F	11.6	Cross-sectional Nonelite (USA)	Hafner (PRPR)	-1.3
Claessens et al. (1998)	36	F	6-14 (range)	Cross-sectional	Hafner (PRPR-right)	-1.6

				Nonelite (Flemish/Belgium)	(PRPR-left)	-0.8
					(DIDI-right)	-4.8
					(DIDI-left)	-4.9
DiFiori et al. (2002)	59	M+F	9.3	Cross-sectional Nonelite (USA)	Hafner (PRPR)	-1.7
Claessens et al. (2003)	16	F	6-13 (range)	Prospective cohort Nonelite (Flemish/Belgium)	Hafner (DIDI)	-3.4/-6.0 (range)
Dwek et al. (2009)	10	F	14.2	Retrospective cohort Nonelite (USA)	Hafner (PRPR) (measured on MRI)	-0.18
Amaral et al. (2011)	33	F	11.1	Cross-sectional Nonelite + elite (Portugal)	Hafner (PRPR-right) (PRPR-left)	-2.2 -1.7
					(DIDI-right)	-3.1
					(DIDI -left)	-2.8

^aThe method *Hafner* refers to Hafner et al. (1989) / *PRPR* refers to the measurement obtained using the distance from the most proximal point of the ulnar metaphysis to the most proximal point of the radial metaphysis / *DIDI* refers to the distance from the most distal point of the ulnar metaphysis to the most distal point of the radial metaphysis / *Perpendicular* refers to the method described by Steyers and Blair (1989).

Table 2. *Cross-sectional and cohort data of ulnar variance measurements in mature (fused physes) reference and gymnasts samples.*

Reference	Sample studied			Type of study Skill / level	UV method ^a	Mean UV (mm)
	N	Gender	Mean age (yr)			
<i>Mature populations</i>						
Chang et al. (1995)	25	M+F	15.0	Prospective cohort Musicians (China)	Perpendicular	+0.89
Freedman et al. (1998)	100	M+F	19-61 (range)	Cross-sectional Volunteer sample (USA)	Perpendicular	Left: -0.13 Right: -0.29
Schuurman et al. (2001)	68	M+F	18-65 (range)	Cross-sectional Patients (Netherlands)	Palmer	Left: +0.22 Right: +0.10
Yeh et al. (2001)	15	M+F	22-46 (range)	Cross-sectional Volunteer sample (USA)	Perpendicular	-0.8
Jung et al. (2001)	120	M+F	20-35 (range)	Cross-sectional Volunteer sample (Korea)	Perpendicular	+0.74
Sönmez et al. (2002)	41	M	19-24 (range)	Cross-sectional Volunteer sample (Turkey)	Perpendicular	+0.06
Unver et al. (2004)	102	M+F	18-24 (range)	Cross-sectional Medical students and nurses (Turkey)	Palpation	UV minus: n = 59 UV neutral: n = 43
Yoshioka et al. (2007)	29	M+F	27.0	Cross-sectional Volunteer sample (Japan)	MRI	+0.05

Chen and Wang (2008)	864	M+F	23-69 (range)	Prospective cohort Volunteer sample (Taiwan)	Palmer	+0.38
Ertem et al. (2009)	77	M+F	14-71 (range)	Cross-sectional Volunteer sample (Turkey)	Perpendicular	<u>Dominant hand</u> Positive: 5.2% Neutral: 75.3% Negative: 19.5% <u>Nondominant hand</u> Positive: 7.8% Neutral: 75.3% Negative: 16.9%
<i><u>Mature gymnasts</u></i>						
Mandelbaum et al. (1989)	20	M: n=11 F: n=9	18-23 (range)	Cross-sectional Collegiate champions (USA)	Palmer	Males: +2.82 Females: +1.44
Mandelbaum et al. (1989)	18	M	19-23 (range)	Cross-sectional Collegiate sublevel (USA)	Palmer	+1.28
De Smet et al. (1994)	35	F	17-23 (range)	Cross-sectional World-top / international	Palmer	+1.9
Chang et al. (1995)	85	M+F	15.0	Prospective cohort Chinese opera students	Perpendicular	+1.29

^a **Perpendicular** refers to the method described by Steyers and Blair (1989) / **Palmer** refers to the method described by Palmer et al. (1982) / **MRI** refers to Magnetic resonance imaging..

Table 3. Overview of ulnar variance in gymnasts versus control subjects: statistically controlled.

Reference	Gymnasts (G)			Controls (C)			UV - method
	n	Gender	Characteristics	n	Gender	Characteristics	UV differences between G and C Significance level
<i>Immature samples (unfused physes)</i>							
Chang et al. (1995)	176	M+F	Chinese opera students	38	M+F	Chinese musicians	Perpendicular Mean UV-G = +0.07 mm Mean UV-C = -0.05 mm Not significant
Claessens et al. (1997)	60	F	Elite Flemish gymnasts	36	F	Recreational gymnasts	Hafner (DIDI) Range UV-G = -3.5 mm / -5.6 mm Range UV-C = -3.2 mm / -6.1 mm Not significant
DiFiori et al. (1997)	12	M+F	Nonelite gymnasts (USA)	535	M+F	Sample studied by Hafner et al. (1989)	Hafner (PRPR) Mean UV-G = -1.1 mm Mean UV-C = -2.3 mm Significant (p < 0.05)
DiFiori et al. (2002)	59	M+F	Nonelite gymnasts (USA)	535	M+F	Sample studied by Hafner et al. (1989)	Hafner (PRPR) Mean UV-G = -1.7 mm Mean UV-C = -2.3 mm Significant (p < 0.006)
Dwek et al. (2009)	10	F	Nonelite gymnasts (USA)	535	M+F	Sample studied by Hafner et al. (1989)	Hafner (PRPR) Mean UV-G = -0.18 mm Mean UV-C = -2.3 mm Significant (p < 0.05)

Mature samples (fused physes)

Mandelbaum et al. (1989)	11	M	Elite gymnasts (USA)	20	M	Age-matched non-athletes Palmer	
	18	M	Nonelite gymnasts (USA)			Mean UV-Males G-elite = +2.82 mm	
	9	F	Elite gymnasts (USA)	5	F	Age-matched non-athletes	Mean UV-Males G-nonelite = +1.28 mm Mean UV-females G = +1.44 mm Mean UV-Males C = -0.62 mm Mean UV-Females C = -0.42 mm Gymnasts/controls: significant (p < 0.01) Males elite/nonelite: significant (p < 0.01)
De Smet et al.	35	F	World-top / international gymnasts	125	F	Matched non-athletes	Palmer (1994) Mean UV-G = +1.9 mm Mean UV-C = -0.43 mm Highly significant
Chang et al. (1995)	85	M+F	Chinese opera students	25	M+F	Chinese musicians	Perpendicular Mean UV-G = +1.29 mm Mean UV-C = +0.89 mm Significant (p < 0.05)

Table 4. Age and gender related ulnar variance data (UV, in mm) in immature and mature reference samples: an overview.

Reference	Sample studied						Description sample Type of study	Results
	Total group		Males		Females			
	n	age (y) ¹	n	age (y)	n	age (y)		
Nakamura et al. (1991)	325	14-79	203	?	122	?	Volunteers (Japanese) Cross-sectional	Relation UV-age: $r = +0.36$ ($p < 0.001$) Mean UV of males (-0.14) was significant lower compared to females (+0.77)
Schuind et al; (1992)	120	25-60	30	25-40	30	25-40	Volunteers USA Cross-sectional	UV not significantly related with age Mean UV age group '25-40' = -0.9 Mean UV age group '41-60' = -0.9 UV not significantly related with gender Mean UV for males and females = -0.9
Freedman et al. (1998)	100	19-61	42	?	58	?	Volunteers USA Cross-sectional	UV not significantly related with age and gender (no data given)
Jung et al. (2001)	120	20-35	60	?	60	?	Volunteers (Korea) Cross-sectional	UV significantly related with gender Mean UV of males (+0.45) was significant lower compared to females (+1.03)
Yoshioka et al. (2007)	29	14-67	?	?	?	?	Volunteers (Japan) Cross-sectional	Relation UV-age: $r = +0.16$ (n.s.) Mean UV males (+0.11) not significant different of females +0.01)
Chen and Wang (2008)	864 ²	23-69	471		393		Volunteers (Taiwan) Longitudinal	At the initial stage, mean UV of males (+0.40) was not significantly different of mean UV of females (+0.35)
	864 ²	42-81	471		393			

								Mean UV at the initial stage (+0.38) was not significantly different of mean UV at the final stage (+0.38)
Hafner et al. (1989)	535	2-15	276	2-15	259	2-15	Reference (USA) Cross-sectional	UV measures (PRPR and DIDI) ³ change very little with age, but the ranges of both measures increased significantly with age. Range PRPR at age 2: -0.3 / -3.8 Range PRPR at age 15: +2.4 / -7.0 Range DIDI at age 2: -0.7 / -4.1 Range DIDI at age 15: +1.8 / -7.5 Gender was not significant.

¹ Age is given in range and expressed in years

² Longitudinally followed over a period between 17 and 22 years. Start of the study is indicated as initial stage and the end of the study is indicated as final stage.

³ PRPR refers to the measurement obtained using the distance from the most proximal point of the ulnar metaphysis to the most proximal point of the radial metaphysis / DIDI refers to the distance from the most distal point of the ulnar metaphysis to the most distal point of the radial metaphysis.

Table 5. *Relationship between ulnar variance and biological parameters in gymnastics samples: an overview.*

Reference	<u>Sample studied</u>			Results
	N	Gender	Age (y)	
<i>Immature gymnasts</i>				
De Smet et al. (1994)	156	F	13.1 - 20.6	UV not significantly related with chronological age. UV significantly ($p < 0.01$) related with height and weight (r varying from 0.15 to 0.22). Taller and heavier gymnasts have a tendency to a positive UV.
Claessens et al. (1996)	156	F	13.1 - 20.6	UV not significantly related with chronological age. UV significantly ($p < 0.01$) related with skeletal age (r varying from 0.16 to 0.22). No relationship with age at menarche. UV significantly ($p < 0.01$) related with a 'muscle component' ($r = 0.25$). Gymnasts who are more mature and are relative tall with a high lean body mass are at greater risk for developing a positive UV.
Claesens et al. (1997)	36	F	6 - 14	With increasing age a negative UV becomes more pronounced.
DiFiori et al. (1997)	44	M+F	5 - 16	UV not significantly related with chronological age, height and weight.
Beunen et al. (1999)	201	F	13.1 - 23.8	The group of gymnasts with positive UV ($UV > 2$ mm) have advanced skeletal ages ($SA - CA = -0.5$ y) compared to the group of gymnasts with negative UV ($UV < -1$ mm / $SA - CA = -1.7$ y). A positive UV was apparently associated with more advanced maturity

				status of the ulna.
DiFiori et al. (2002)	59	M+F	5 - 16	UV was not significantly related with chronological age.
Claessens et al. (2003)	16	F	6 - 13	UV is not related with height, weight and skeletal age.
Dwek et al. (2009)	10	F	12 - 16	With increasing age was observed more positive UV.
Amaral et al. (2011) stature	33	F	7.2 - 15.4	UV is significantly ($p < 0.05$) associated with skeletal age ($r = 0.38$), ($r = 0.41$), and fat-free mass ($r = 0.48$)

Table 6. Overview of left-right difference of ulnar variance (PRPR) measurements.

Reference	Population			Method ^a	Left site	Right site	Difference
	N	Age (y) / Gender	Sample				
DiFiori et al. (1997)	2	≤ 6 / M+F	nonelite gymnasts	PRPR	-1.0	-1.5	0.5
	30	7-13 / M+F	nonelite gymnasts	PRPR	-2.0	-2.1	0.1
	12	14-15 / M+F	nonelite gymnasts	PRPR	-1.6	-1.6	0.0
Claessens et al. (1998)	36	8-14 / F	nonelite gymnasts	PRPR	-0.8	-1.6	0.8 *
				DIDI	-4.9	-4.8	0.1
Freedman et al. (1998)	100	19-61 / M+F	adult reference data	Perpendicular	-0.13	-0.29	0.16
DiFiori et al. (2002)	59	5-16 / M+F	nonelite gymnasts	PRPR	?	?	0.7
Amaral et al. (2011)	33	7-15 / F	nonelite gymnasts	PRPR	-1.7	-2.2	0.5*
				DIDI	-2.8	-3.1	0.3

^a **PRPR** and **DIDI** refers to the method of Hafner et al.(1989) / **PRPR** refers to the measurement obtained using the distance from the most proximal point of the ulnar metaphysis to the most proximal point of the radial metaphysis / **DIDI** refers to the measurement obtained using the distance from the most distal point of the ulnar

metaphysis to the most distal point of the radial metaphysis / **Perpendicular** refers to the method described by Steyers and Blair (1989).

* $p \leq 0.05$

Table 7. Relationship between UV and handgrip strength: an overview.

Reference	Sample			Results	
	n	Gender	Sample characteristics	Mean UV (mm)	Relation with hand grip
<i>Immature wrists</i>					
DiFiori et al. (2002a)	59	M+F	Nonelite gymnasts (USA)	-1.7	No association
<i>Mature wrists</i>					
Freedman et al. (1998)	100	M+F	Adult reference sample	<u>Unloaded</u> Left = -0.13 Right = -0.29 <u>Loaded</u> Left = +0.93 Right = +0.82	Not significant differences on average of measurements between right and left unloaded or loaded wrists. Significant individual variations between unloaded and loaded wrists.
Schuurman et al. (2001)	68	M+F	Patients (The Netherlands)	<u>Unloaded</u> Left = +0.22 Right = +0.10 <u>Loaded</u> Left = +2.37 Right = +2.18	With maximum strength (loaded) a significant increase towards positive UV is observed.
Sönmez et al. (2002)	41	M	Volunteer sample (Turkey)	<u>Unloaded</u> +0.06 <u>Loaded</u> +1.87	The difference in UV between unloaded and loaded was significant. UV increase with increase in grip strength. UV during grip strength was increased in wrists with negative UV and greater than those with positive UV

Table 8. *Relationship between UV and forearm/wrists position: an overview.*

Reference	Sample			Results	
	n	Gender	Characteristics	Mean UV (mm)	Relation with forearm / wrists position
<i>Mature wrists</i>					
Schuurman et al. (2001)	68	M+F	Patients (Netherlands)	Neutral = +0.16 Left = +0.22 Right = +0.10 Supination = -0.26 Left = -0.22 Right = -0.29 Ulnar deviation = +0.30 Radial deviation = +0.32	Significant differences were found between UV and different wrist positions. Neutral / supination: significant (p < 0.01). Ulnar / radial deviation: Not significant.
Yeh et al. (2001)	15	M+F	Volunteer sample (USA)	Neutral = -0.8 Pronation = -0.4 Supination = -1.0	UV decreased with the forearm rotation from pronation to supination. Pronation / neutral: significant (p < 0.01) Pronation / supination: significant (p < 0.01) Neutral / supination: not significant (p = 0.09)
Jung et al. (2001)	120	M+F	Volunteer sample (Korea)	Neutral = +0.74 Pronation = +1.07 Supination = +0.19	Forearm rotation can influence UV. UV tended to increase with pronation and decrease with supination.
Sönmez et al. (2002)	41	M	Volunteer sample (Turkey)	Neutral = +0.06	UV is affected by forearm rotations.

Unver et al. (2004)	102	M+F	Medical students and nurses (Turkey)	Neutral = +0.06	Ulnar deviation was greater in negative UV: significant ($p < 0.02$). Radial deviation was greater in neutral UV: significant ($p < 0.035$). In the total range of radio-ulnar deviation in neutral or negative UV: not significant.
---------------------	-----	-----	--------------------------------------	-----------------	--

Hypothetically, the gymnasts with the highest absolute values of negative UV are expected to present more pain and radiologic changes in the radial growth plate, and consequently pain on the radial side, as well as during the execution of supination and ulnar deviation. These movements increase distal radial slide, accentuating the negative UV and increasing the percentage of load on the radius. Oppositely, for individuals with positive UV, the distal ulnar and its interface with the carpal bones may have a greater probability of suffering damage or injuries.

Training characteristics

During the last decade a significant increase in the duration, the volume and intensity of AG training is observed as shown in several studies (Caine, Bass & Daly, 2003), with reports from elite gymnasts who train about 40 h/week, 5-6 days/week, throughout the year (Caine, Lewis, O'Connor, Howe & Bass, 2001; Daly et al., 2001; Dixon & Fricker, 1993; Kirialanis et al., 2002). According to some authors (Gabel, 1998; Kolt & Kirkby, 1999), the percentage of injuries is proportional to the amount of training time and the skill level due to the increase of time exposed to increased difficulty in competition routines.

The injury profile depends on the amount of time spend in the sports environment (Gabel, 1998) and as demonstrated in several studies, the excessive stress on the skeleton of elite gymnasts is caused by the number of repetitions of a specific movement (DiFiori et al., 2006; Roy et al., 1985). In most studies, especially case-reports, the authors suggest a dose-response relationship between training characteristics, competition level and UV (Claessens, 2001; 2004). Thus, the higher the gymnasts' training and/or competition level, the more pronounced positive ulnar variance is observed (Caine et al., 1992; Chang et al., 1995; DiFiori et al., 2002a; Roy et al.,

1985). However, there does not appear to be a consensus on this matter. In a study on a representative sample of 156 skeletally immature elite female gymnasts (participants in world championships), Claessens et al. (1996) did not find any significant correlation between training status and competition scores on the one hand, and UV on the other hand, correlation values varied from $r = -0.11$ (r between starting age and UV) and $r = +0.15$ (r between competition score on uneven bars and ulnar variance). DiFiori et al. (1997) also did not find a significant association between ulnar variance and training history in 44 nonelite male and female gymnasts. Based on data gathered on 36 female gymnasts who were followed longitudinally for four years, Claessens et al. (1997) could not show a significant influence of gymnastics training load and the ulnar variance phenomenon. On the other hand, DiFiori et al. (2002a) found a significantly higher positive UV in a group of elite collegiate gymnasts compared to a group of nonelite collegiate gymnasts. According to Beunen et al. (1999), studying the association between skeletally assessed maturation and gymnastics training in a group of highly-skilled world-level female gymnasts, was frequently found positive UV in gymnasts that may not have resulted from gymnastics overload. Also, based on data gathered on 36 skeletally immature female gymnasts in which UV was measured annually over 7 or 8 years, Claessens et al. (2003) have shown that the observed negative UV at the start of the study became more pronounced over the years when training level increased, contradicting the results of positive UV found in the literature. For this reason, some authors consider that AG training does not have a direct negative impact in the relative position of the distal extremities of the ulna compared to the radius, resulting in an ulna's overgrowth. Other studies have also pointed out that there is no significant relationship between UV and intensity or volume of gymnastics training (Claessens,

2001; 2004; De Smet, 1994; DiFiori et al., 1997).

Although several authors indicate that injuries may be related to the difficulty of sports skills and the athlete's capability (Kolt & Kirkby, 1999; Sands, Shultz & Newman, 1993), several studies didn't find any significant association between training or competition level and UV, neither in high level athletes nor recreational groups (Claessens et al., 1996; Claessens et al., 1997; De Smet, 1994). In contrast, DiFiori et al. (2002a) have found associations between UV, higher skill level, and years of training.

The stress changes in the growth plate and the long-term consequence in the chronically stressed wrists of adolescent gymnasts was also observed by Chang et al. (1995) over many years of training. They found that the tendency toward positive UV ranged from 23.6% in the 1st year of training to 81% in the 8th year of training (Chang et al., 1995). In contrast, Claessens et al. (1997) found a tendency toward negative UV varying between -3.4 and -6.5 mm for DIDI.

LIMITATIONS

The research on this matter often presents contradictory results, which can be caused by the disparity of sample characteristics, lack of criteria concerning the training level, number of subjects studied, or even the different evaluation techniques used and their reliability, resulting in a lack of consensus concerning the type of UV in gymnasts. Because most studies are cross-sectional designs, there are many controversial results which do not allow the determination of precise relationships. Longitudinal studies are needed in order to study more effectively the amount of response or influence of training in the UV phenomenon.

There is a lack of information about UV normative values related to age, gender and ethnic groups which would make it easier to detect and distinguished the abnormalities in athletes submitted to a

weight bearing on the wrists. It is also important to point out that the majority of recent researches involving UV investigate this phenomenon in patients with already established diseases and therefore without assessing its ethiology or evolution.

PRACTICAL APPLICATIONS OR PREVENTIVE MEASURES

Based on the presented information related to the UV and respective causes or consequences, prevention should be an important aspect of a gymnast's training regimen (Webb & Rettig, 2008). In this context, a periodic physical examination should be carried out to allow an accurately diagnosis at an early stage of the stress related to growth plate and other overuse wrist injuries. When indicated, radiographs of symptomatic physeal areas should be administered to rule out stress changes (Caine, 2003; Caine et al., 2006; Kolt & Kirkby, 1999).

Due to the frequency and high level of impacts that gymnasts suffer during AG practice, coaches should reduce training loads and delay some skill progressions for young gymnasts during growth spurts (Caine, 2003; Caine et al., 1996; Caine et al., 1992; DiFiori et al., 2006; Webb & Rettig, 2008). In order to easily identify the referred period of rapid growth they should have a control of the height measurements at three month intervals or quarterly height measurements (Caine, 2003; Caine et al., 2006; DiFiori et al., 2006).

Coaches should also use a variety of drills or activities during the training to avoid excessively repetitive movements that may result in overuse injury. Emphasis should be on quality of workouts rather than training volume (Caine et al., 2006) and the training load should be gradually increased (Daly et al., 2001; Webb & Rettig, 2008). Another possibility to lighten the load can be the alternation of loading types during workouts (DiFiori et al., 2006; Webb & Rettig, 2008), alternating between movements of swing and support to reduce stress and the intensity of compressive

loading on the wrist (Caine, 2003; DiFiori et al., 2006; Mitchell & Adams, 1994; Roy et al., 1985).

It is also important to consider the possibility of use wrists orthoses (Webb & Rettig, 2008). Nowadays many gymnasts use various types of wrist braces and biomechanical and clinical studies indicate that such devices may protect against acute injury and may reduce ulnocarpal joint pressure during loading (DiFiori et al., 2006; Grant-Ford, Sitler, Kozin, Barbe & Barr, 2003), mainly the skeletally mature gymnasts with a positive UV. Brooks (2001) have reported a case where the use of wrist brace, combined with palmar wrist tape, proved effective in preventing end-range of the wrist extension while still allowing the athlete adequate mobility to successfully perform the skills. However, the biomechanical studies of wrist bracing have not been performed in specimens with a negative UV, so the potential effects of using such braces in young gymnasts, who typically have a negative UV, are not known (DiFiori et al., 2006).

The use of devices with bearing surfaces adapted to reduce the pressure of the impacts can be a useful strategy, especially during the sensitive phases of rapid growth. Foam beam covers and padded vault should be used to absorb the shock of impact (Daly et al., 2001; Mandelbaum et al., 1989; Mitchell & Adams, 1994).

Finally, because UV and related factors cannot be dissociated from the maturation status of the gymnasts, training and skill development should be individualized (Caine, 2003; DiFiori et al., 2006) to reduce risk of acute and stress related physeal injury (Caine et al., 2006). To ensure that the specific physical characteristics and maturation are considered throughout the training process it is important that everyone involved work as a team (gymnast, coach, physician, parents and medical staff) with open channels of communication (Caine et al., 2006).

CONCLUSIONS

The gymnast's wrist is a place of great incidence of painful symptomatology and injury, leading to the formulation of several hypotheses concerning the UV etiology. Based on the previous assumption, it seems relevant to determine the circumstances in which gymnasts have an increased risk of developing changes in reference values of UV and which are the causes of pain and functional disability, in order to reduce the occurrence, recurrence and severity of injuries. In this context, it is important to carry out longitudinal studies, which take into account the gymnasts' pre- or post-pubescent stages, controlling as much as possible for confounding variables. Most of the available studies are based on patients or case reports. In fact, in case-study or in cross-sectional research, the temporal association between exposure and outcome is unclear. In many similar studies or nonrandomized interventions, various sources of bias were detected namely the selection of subjects, methodological concerns, measurement of exposure and outcome variables, and lack of control concerning other potentially confounding variables which may threaten the studies' internal validity. Future clinical trials looking for prevention strategies should quantify and control the potential risk factors for injury in young gymnasts, including changes in the physis growth plate from distal radius and/or ulna. It is important to diagnose quickly and accurately the specific injury to adapt training and to appropriately initiate the treatment and limit the extent of injuries. Prevention should also be an important aspect of a gymnast's training regimen during all activity.

REFERENCES

Amaral, L., Claessens, A.L., Ferreirinha, J. & Santos, P. (2011). Ulnar variance related to biological and training characteristics and handgrip strength in Portuguese skeletally immature female gymnasts. *Submitted*.

Anderson, J., Read, J. & Steinweg, J. (1998). *Atlas of Imaging in Sports Medicine*. Australia: Mc Graw Hill.

Arora, A.S. & Chung, K.C. (2006). Otto W. Madelung and the recognition of Madelung's deformity. *The Journal of Hand Surgery (American)*, 31(2), 177-182.

Beunen, G., Malina, R.M., Claessens, A.L., Lefevre, J. & Thomis, M. (1999). Ulnar variance and skeletal maturity of radius and ulna in female gymnasts. *Medicine and Science in Sports and Exercise*, 31(5), 653-657.

Boyle, K., Witt, P. & Riegger-Krugh. (2003). Intrarater and Interrater Reliability of the Beighton and Horan Joint mobility Index. *Journal Athletic Training* 38(4), 281-285.

Brooks, T.J. (2001). Madelung Deformity in a Collegiate Gymnast: A Case Report. *Journal of Athletic training*, 36(2), 170-173.

Bu, J., Patterson, R.M., Morris, R., Yang, J. & Viegas, S.F. (2006). The effect of radial shortening on wrist joint mechanics in cadaver specimens with inherent differences in ulnar variance. *The Journal of Hand Surgery (American)*, 31(10), 1594-1600.

Caine, D.J. (2003). Injury Epidemiology. In W. Sands, D. Caine & J. Borms (Eds.), *Scientific Aspects of Women's Gymnastics* (Vol. 45, pp. 72-109). Basel: Karger.

Caine, D.J., Bass, S.L. & Daly, R.M. (2003). Does elite competition inhibit growth and delay maturation in some gymnasts? Quite possibly. *Pediatric Exercise Science*, 15, 360-372.

Caine, D.J., DiFiori, J. & Maffulli, N. (2006). Physeal injuries in children's and youth sports: reasons for concern? *British Journal of Sports Medicine*, 40(9), 749-760.

Caine, D.J., Howe, W., Ross, W. & Bergman, G. (1997). Does repetitive physical loading inhibit radial growth in female gymnasts? *Clinical Journal of Sport Medicine*, 7(4), 302-308.

Caine, D.J., Lewis, R., O'Connor, P., Howe, W. & Bass, S.L. (2001). Does gymnastics training inhibit growth of

females? *Clinical Journal of Sport Medicine*, 11(4), 260-270.

Caine, D.J., Lindner, K. J., Mandelbaum, B. R. & Sands, W. A. (1996). Gymnastics. In D. J. Caine, C. G. Caine & K. J. Lindner (Eds.), *Epidemiology of Sports Injuries* (pp. 213-246). Champaign, Ill: Human Kinetics.

Caine, D.J., Roy, S., Singer, K.M. & Broekhoff, J. (1992). Stress changes of the distal radial growth plate. A radiographic survey and review of the literature. *The American Journal of Sports Medicine*, 20(3), 290-298.

Cerezal, L., del Pinal, F., Abascal, F., Garcia-Valtuille, R., Pereda, T. & Canga, A. (2002). Imaging findings in ulnar-sided wrist impaction syndromes. *Radiographics*, 22(1), 105-121.

Chang, C.Y., Shih, C., Penn, I.W., Tiu, C.M., Chang, T. & Wu, J.J. (1995). Wrist injuries in adolescent gymnasts of a Chinese opera school: radiographic survey. *Radiology*, 195(3), 861-864.

Chen, W. S. & Wang, J.W. (2008). Ageing does not affect ulnar variance: an investigation in Taiwan. *The Journal of Hand Surgery (European)*, 33(6), 797-799.

Claessens, A.L. (2001). Ulnar variance in female gymnasts: an overview. In M. Lenoir & R. M. Philippaerts (Eds.), *Science in Artistic Gymnastics* (pp. 61-71). Gent: Publicatiefonds voor Lichamelijke Opvoeding.

Claessens, A.L. (2004). Gymnast wrist: the ulnar variance phenomenon. In M. Silva & R. Malina (Eds.), *Children and Youth in organized Sports* (pp. 290-298). Coimbra: Coimbra University Press.

Claessens, A.L., Leen, V., Inge, B., Lefevre, J., Renaat, P. & Martine, T. (2003). Relationship Between Ulnar Variance and Morphological Characteristics in Female Gymnasts, A Longitudinal Study. *Portuguese Journal of Sport Science*, 3(2), 68-69.

Claessens, A.L., Lefevre, J., Beunen, G., De Smet, L. & Veer, A.M. (1996). Physique as a risk factor for ulnar variance in elite female gymnasts. *Medicine and*

Science in Sports and Exercise, 28(5), 560-569.

Claessens, A.L., Lefevre, J., Philippaerts, R., Thomis, M. & Beunen, G. (1997). The ulnar variance phenomenon: a study in young gymnasts. In N. Armstrong, B. Kirby & J. Welsman (Eds.), *Children and Exercise XIX* (pp. 537-541). London: England: E&FN Spon.

Claessens, A.L., Moreau, M. & Hochstenbach, L. (1998). Rotational direction and the ulnar variance phenomenon in young female gymnasts. *Journal of Sports Sciences and Medicine*, 16(5), 431-432.

Daly, R.M., Bass, S.L. & Finch, C.F. (2001). Balancing the risk of injury to gymnasts: how effective are the counter measures? *British Journal of Sports Medicine*, 35, 8-19.

De Smet, L. (1994). Ulnar variance: facts and fiction review article. *Acta Orthopaedica Belgica*, 60(1), 1-9.

De Smet, L., Claessens, A.L. & Fabry, G. (1993). Gymnast wrist. *Acta Orthopaedica Belgica*, 59(4), 377-380.

De Smet, L., Claessens, A.L., Lefevre, J. & Beunen, G. (1994). Gymnast wrist: an epidemiologic survey of ulnar variance and stress changes of the radial physis in elite female gymnasts. *The American Journal of Sports Medicine*, 22(6), 846-850.

DiFiori, J.P., Caine, D.J. & Malina, R.M. (2006). Wrist pain, distal radial physeal injury, and ulnar variance in the young gymnast. *The American Journal of Sports Medicine*, 34(5), 840-849.

DiFiori, J.P. & Mandelbaum, B.R. (1996). Wrist pain in a young gymnast: unusual radiographic findings and MRI evidence of growth plate injury. *Medicine and Science in Sports and Exercise*, 28(12), 1453-1458.

DiFiori, J.P., Puffer, J.C., Aish, B. & Dorey, F. (2002a). Wrist pain, distal radial physeal injury, and ulnar variance in young gymnasts: does a relationship exist? *The American Journal of Sports Medicine*, 30(6), 879-885.

DiFiori, J.P., Puffer, J.C., Aish, B. & Dorey, F. (2002b). Wrist Pain in Young

Gymnasts: Frequency and Effects Upon Training Over 1 Year. *Clinical Journal of Sport Medicine*, 12, 348-353.

DiFiori, J.P., Puffer, J.C. & Dorey, F. (2001). Ulnar variance in young gymnasts: a three-year study. *Medicine and Science in Sports and Exercise*, 33, S223.

DiFiori, J.P., Puffer, J.C., Mandelbaum, B.R. & Dorey, F. (1997). Distal radial growth plate injury and positive ulnar variance in nonelite gymnasts. *The American Journal of Sports Medicine*, 25(6), 763-768.

Dixon, M. & Fricker, P. (1993). Injuries to elite gymnasts over 10 yr. *Medicine and Science in Sports and Exercise*, 25(12), 1322-1329.

Dwek, J.R., Cardoso, F. & Chung, C.B. (2009). MR imaging of overuse injuries in the skeletally immature gymnast: spectrum of soft-tissue and osseous lesions in the hand and wrist. *Pediatric Radiology*, 39(12), 1310-1316.

Emery, C.A. (2003). Risk factors for injury in child and adolescent sport: a systematic review of the literature. *Clinical Journal of Sport Medicine*, 13(4), 256-268.

Ertem, K., Kekilli, E., Karakoç, Y. & Yologlu, S. (2009). The changes in bone mineral density of the forearm and distal radius-ulnar subcortical bone due to ulnar variance. *European Journal of Orthopaedic Surgery and Traumatology*, 19, 237-241.

Freedman, D.M., Edwards, G.S., Jr., Willems, M.J. & Meals, R.A. (1998). Right versus left symmetry of ulnar variance. A radiographic assessment. *Clinical Orthopaedics and Related Research*, (354), 153-158.

Gabel, G.T. (1998). Gymnastic wrist injuries. *Clinics in Sports Medicine*, 17(3), 611-621.

Grant-Ford, M., Sitler, M.R., Kozin, S.H., Barbe, M.F. & Barr, A.E. (2003). Effect of a prophylactic brace on wrist and ulnocarpal joint biomechanics in a cadaveric model. *The American Journal of Sports Medicine*, 31(5), 736-743.

Hafner, R., Poznanski, A.K. & Donovan, J.M. (1989). Ulnar variance in children--standard measurements for

evaluation of ulnar shortening in juvenile rheumatoid arthritis, hereditary multiple exostosis and other bone or joint disorders in childhood. *Skeletal Radiology*, 18(7), 513-516.

Jung, J.M., Baek, G.H., Kim, J.H., Lee, Y.H. & Chung, M.S. (2001). Changes in ulnar variance in relation to forearm rotation and grip. *The Journal of Bone Joint Surgery (British)*, 83(7), 1029-1033.

Keats, T. & Sistrom, C. (2001). *Atlas of Radiologic Measurement* (7 ed.): Elsevier Health Sciences.

Kirialanis, P., Malliou, P., Beneka, A., Gourgoulis, V., Gifostidou, A. & Godolias, G. (2002). Injuries in artistic gymnastic elite adolescent male and female athletes. *Journal of Back and Musculoskeletal Rehabilitation*, 16, 145-151.

Koh, T.J., Grabiner, M.D. & Weiker, G.G. (1992). Technique and ground reaction forces in the back handspring. *The American Journal of Sports Medicine*, 20(1), 61-66.

Kolt, G.S. & Kirkby, R.J. (1999). Epidemiology of injury in elite and subelite female gymnasts: a comparison of retrospective and prospective findings. *British Journal of Sports Medicine*, 33(5), 312-318.

Mandelbaum, B.R., Bartolozzi, A.R., Davis, C.A., Teurlings, L. & Bragonier, B. (1989). Wrist pain syndrome in the gymnast. Pathogenetic, diagnostic, and therapeutic considerations. *The American Journal of Sports Medicine*, 17(3), 305-317.

Mann, F.A., Wilson, A.J. & Gilula, L.A. (1992). Radiographic evaluation of the wrist: what does the hand surgeon want to know? *Radiology*, 184(1), 15-24.

Mitchell, J. & Adams, B. (1994). Hand and Wrist Injuries. In P. Renström (Ed.), *Clinical Practice of Sports Injury Prevention and Care* (Vol. V, pp. 63-85). Oxford: Blackwell Scientific Publications.

Nakamura, R., Tanaka, Y., Imaeda, T. & Miura, T. (1991). The influence of age and sex on ulnar variance. *The Journal of Hand Surgery (British)*, 16(1), 84-88.

Nishiwaki, M., Nakamura, T., Nakao, Y., Nagura, T. & Toyama, Y. (2005). Ulnar

shortening effect on distal radioulnar joint stability: a biomechanical study. *The Journal of Hand Surgery (American)*, 30(4), 719-726.

O'Connor, P.J., Lewis, R.D. & Boyd, A. (1996). Health concerns of artistic women gymnasts. *Sports Medicine*, 21(5), 321-325.

Palmer, A.K., Glisson, R.R. & Werner, F.W. (1982). Ulnar variance determination. *The Journal of Hand Surgery (American)*, 7(4), 376-379.

Roy, S., Caine, D.J. & Singer, K.M. (1985). Stress changes of the distal radial epiphysis in young gymnasts. A report of twenty-one cases and a review of the literature. *The American Journal of Sports Medicine*, 13(5), 301-308.

Sands, W.A., Shultz, B.B. & Newman, A.P. (1993). Women's gymnastics injuries. A 5-year study. *The American Journal of Sports Medicine*, 21(2), 271-276.

Schuind, F. A., Linscheid, R. L., An, K. N. & Chao, E. Y. (1992). A normal data base of posteroanterior roentgenographic measurements of the wrist. *The Journal of Bone and Joint Surgery (American)*, 74(9), 1418-1429.

Schuurman, A.H., Maas, M., Dijkstra, P.F. & Kauer, J.M. (2001). Assessment of ulnar variance: a radiological investigation in a Dutch population. *Skeletal Radiology*, 30(11), 633-638.

Sönmez, M., Turaclar, U.T., Tas, F. & Sabanciogullari, V. (2002). Variation of the ulnar variance with powerful grip. *Surgical and Radiologic Anatomy*, 24(3-4), 209-211.

Steyers, C.M. & Blair, W.F. (1989). Measuring ulnar variance: a comparison of techniques. *The Journal of Hand Surgery (American)*, 14(4), 607-612.

Tomaino, M.M. (2000). The importance of the pronated grip x-ray view in evaluating ulnar variance. *The Journal of Hand Surgery (American)*, 25(2), 352-357.

Unver, B., Gocen, Z., Sen, A., Gunal, I. & Karatosun, V. (2004). Normal ranges of ulnar and radial deviation with reference to ulnar variance. *The Journal of International Medical Research*, 32(3), 337-340.

Vandenbussche, S. (2002). Ulnar variance as related to basic motor abilities in female gymnasts: a longitudinal study. (Unpublished master thesis - in Dutch / Prom. Prof. Claessens AL). Katholieke Universiteit Leuven.

Webb, B.G. & Rettig, L.A. (2008). Gymnastic wrist injuries. *Current Sports Medicine Reports*, 7(5), 289-295.

Yeh, G.L., Beredjikian, P.K., Katz, M.A., Steinberg, D. R. & Bozentka, D. J. (2001). Effects of forearm rotation on the clinical evaluation of ulnar variance. *The Journal of Hand Surgery (American)*, 26(6), 1042-1046.

Yoshioka, H., Tanaka, T., Ueno, T., Carrino, J. A., Winalski, C.S., Aliabadi, P., et al. (2007). Study of ulnar variance with high-resolution MRI: correlation with triangular fibrocartilage complex and cartilage of ulnar side of wrist. *Journal of Magnetic Resonance Imaging*, 26(3), 714-719.

Zebala, L.P., Manske, P.R. & Goldfarb, C.A. (2007). Madelung's Deformity: A Spectrum of Presentation. *The Journal of Hand Surgery (British)*, 32(A), 1393-1401.

Corresponding author:

Luísa Amaral

Edifício das Clínicas Pedagógicas

Universidade Fernando Pessoa

Rua Delfim Maia, 334, 2º Sala 7

4200-253 Porto

Portugal

e-mail: lamaral@ufp.edu.pt

RELATION BETWEEN VAULT DIFFICULTY VALUES AND BIOMECHANICAL PARAMETERS IN MEN'S ARTISTIC GYMNASTICS

Almir Atiković¹ & Nusret Smajlović²

¹Faculty of Physical Education and Sport, University of Tuzla, Bosnia and Herzegovina

²Faculty of Physical Education and Sport, University of Sarajevo, Bosnia and Herzegovina

Original research article

Abstract

The aim of the paper is to define which biomechanical parameters explain and define the difficulty vault value. The study sample included 64 vaults from the Code of Points (COP) of the International Gymnastics Federation (FIG, 2009). The dependent variable included all difficulty values ranging from 2-7.2 points, while the sample of independent variables included 12 biomechanical variables (data was collected from the literature and our measurements). With regression analysis we explained 92.4% of the difficulty vault value. Only three biomechanical variables were predictors: degrees of turns around transversal axis, degrees of turns around longitudinal axis and body's moment of inertia around transversal axis in the second flight phase.

Keywords: Code of Point, FIG, vault, men's artistic gymnastics, difficulty, biomechanics.

INTRODUCTION

First ever uniform instructions on Code of Points (COP) in gymnastics under the International Gymnastics Federation (FIG) date back to 1949. The FIG technical committee improves and further develops the COP every four years. Many biomechanical researches have been conducted in the past by Soviet, German, American, Japan, English, Slovene and other researchers (e.g. Šlemin & Ukran, 1977; Gaverdovsky & Smolevsky, 1979; Brueggeman, 1994; Prassas, 1995; Krug, 1997; 1998; Takei, 1998; Čuk & Karácsony, 2004; Marinšek, 2010; Ferkolj, 2010) and knowledge of physical parameters of vaults are generally known. However, rules have not always followed the ever-changing nature of vaults since 1949. More specifically, rules have been late when it comes to the definition of the vault difficulty level. With inclusion of the saltos in the second flight phase, the vault

difficulty becomes defined primarily by body position (tucked, piked or stretched) and the number of rotations around the transversal and longitudinal body axis in the first and second flight phase (COP FIG, 1964; 1971; 1978; 1985; 1989; 1993; 1997; 2001; 2006; 2009). Difficulty values (DV) have changed on the basis of the total number of rotations performed around transversal and longitudinal axis in the first and second flight phase (Table 1). Usually the COP rewarded each new vault with more DV, old vaults had to be awarded fewer DV although the vault remained the same.

The overview of changes and correlations between the DV, shown in (Table 2), illustrate that there have been no significant changes in the past years where correlations are rather high between the DV awarding rules that have been applied up to now. There is a big difference between a COP from 1964 to 2009 year where the correlations less than .47 percent.

Table 1. *Development of handspring style of vaults in COP (FIG) and their difficulty value.*

Year of publication (COP)	Tucked	Points	Piked	Points	Stretched	Points
1964					Forward handspring	10.00
1971	Handspring forward and salto forward tucked	10.00			Forward handspring with ½ turn	10.00
	Handspring forward and salto forward tucked with ½ turn (or Cuervo tucked)	9.8			Forward handspring with 1/1 turn	10.00
1985	Handspring forward and salto forward tucked with 1/1 turn	9.60	Handspring forward and salto forward piked	9.40	Forward handspring with 3/2 turn	9.40
			Handspring forward and salto forward piked with ½ turn	9.40	Handspring forward and salto forward stretched	9.60
					Handspring forward and salto forward tucked stretched with ½ turn (Cuervo stretched)	9.60
1989	Handspring forward and salto forward tucked with 3/2 turn	9.60	Handspring forward and salto forward piked with 3/2 turn	9.60	Forward handspring stretched with 2/1 turn	9.40
					Handspring forward and salto forward stretched with ½ turn (Kroll)	9.60
					Handspring forward and salto forward stretched with 3/2 turn (Lou Yun)	9.60
1993	Handspring forward and double salto forward tucked (Roche)	9.80				
	Handspring forward and double salto forward tucked with 1/2 turn (Xiao Jun Feng)	9.80				
1997					Handspring forward and salto forward stretched with 2/1 turn	10.00
					Handspring forward and salto forward stretched with 5/2 turn (Yeo 2)	10.00
2006	Handspring forward and salto forward tucked with 1/2 turn and salto backward tucked (Zimmerman)	7.0	Handspring forward and double salto forward piked (Blanik)	7.0		
			Handspring forward and double salto forward piked with ½ turn (Dragulescu)	7.2		

Table 2. Correlations between COP (FIG) from 1964 to 2009.

Year of publication	2009-2006	2006-2001	2001-1997	1997-1993	1989-1985	1985-1978	1978-1971	1971-1964	
<i>R</i>	1	0.994	0.932	0.890	0.872	0.875	0.946	0.976	
<i>R</i> ²	1	0.988	0.870	0.793	0.761	0.766	0.894	0.952	
	2006	2001	1997	1993	1989	1985	1978	1971	1964
<i>R</i> 2009	1	0.994	0.931	0.862	0.838	0.823	0.795	0.595	0.475
<i>R</i> ² 2009	1	0.988	0.866	0.744	0.703	0.678	0.632	0.355	0.225

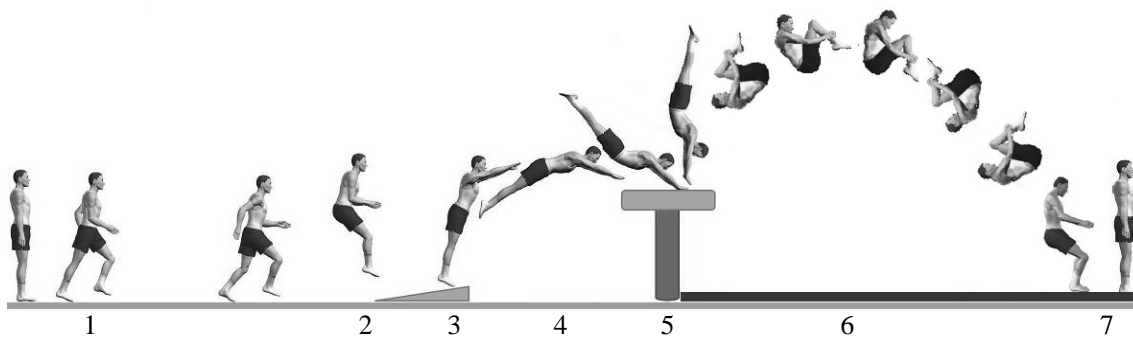

Figure 1. Vault phases: 1-run, 2-jump on springboard, 3-springboard support phase, 4-first flight phase, 5-support on the table, 6-second flight phase, 7-landing.

Each vault in COP can be divided in the following seven phases (Figure 1) (Prassas, 2002; Ćuk & Karácsony, 2004; Takei, 2007; Ferkolj, 2010) run, jump on springboard, springboard support phase, first flight phase, support on the table, second flight phase, and landing.

According to the COP (FIG, 2009), the vault DV is already predetermined in the vault itself and is representative of the level degrees of turns around transversal and longitudinal axis in the first and second flight phase. The gymnast must show the intended body position (tucked, piked or stretched) in a distinct and unmistakable manner. Indistinct body positions are deducted by the E-Jury and may result in recognition as a lower value vault by the D-Jury. Table 3 shows that piked and stretched positions have no impact on DV in sample handspring vaults, while within handsprings with saltos, a general rule appears. Vaults with piked position saltos in the second flight phase have 0.4 higher value than vaults with tucked position saltos; stretched position saltos have 0.8 higher value than piked position saltos. Every increase of 180

degrees turn around longitudinal axis in the second flight saltos adds 0.4 points to the vault DV.

Takei (1998) identified mechanical variables that govern the successful performance of a vault. The following were important determinants of success: large horizontal velocity, large horizontal kinetic energy, and overall translational kinetic energy at take-off from the board; short duration, small vertical displacement of body's center of gravity (BCG), and small somersaulting angular distance of preflight; large vertical velocity and large vertical kinetic energy at take-off from the horse; and large "amplitude of postflight," that is, large horizontal and vertical displacements of BCG and long duration of flight; great height of BCG during the second quarter-turn in postflight; and small point deduction for landing.

Prassas (2002) schematically presented what vaulting success is dependent on and what the significant variables are. Some of them are independent and some are under the gymnastic control, such as: linear postflight displacement of

BCG, postflight somersaults/twist, linear momentum at vault take-off, duration of postflight, angular momentum at vault take-off, BCG vertical velocity, BCG position,

linear at angular momentum at vault contact, change in linear and angular momentum on vault.

Table 3. *Development of handspring style of vaults in COP (FIG, 2009) and their DV.*

Handspring style vaults (III group)	Tucked (points)	Piked (points)	Stretched (points)
Forward handspring		3.0 Yamashita	3.0
Forward handspring with ½ turn		3.4	3.4
Forward handspring with 1/1 turn		3.8	3.8
Forward handspring with 3/2 turn		4.2	4.2
Forward handspring with 2/1 turn		4.6	4.6
Handspring forward and salto	3.8	4.2	5.0
Handspring forward and salto ½ turn (Cuervo)	4.2	4.6	5.4
Handspring forward and salto 1/1 turn (Cuervo with ½ turn)	4.6	5.0	5.8
Handspring forward and salto 3/2 turn (Cuervo with 1/1 turn)	5.0 Kroll	5.4	6.2 Lou Yun
Handspring forward and salto 2/1 turn (Cuervo with 3/2 turn)	5.4 Canbass		6.6
Handspring forward and salto 5/2 turn (Cuervo with 2/1 turn)			7.0 Yeo 2
Handspring forward with 1/1 turn and salto forward	5.4 Behrend	5.8 Rehm	
Handspring forward and salto tucked with ½ turn and salto backward tucked	7.0 Zimmerman		
Handspring double salto forward	6.6 Roche	7.0 Blanik	
Handspring forward and double salto ½ turn	7.0	7.2 Dragulescu	

Schwiezer (2003) found which mechanical variables are important for optimal vault performance: positions of the hands on the table, reaction forces during the support phase of the hands, landing distances behind the table, run velocity, where the gymnast hits the vaulting board, distance of the vaulting board from vault, duration of first and second flight phase.

Čuk & Karacsony (2004) presented biomechanical characteristics of vaulting and the most important factors for successful vault jump e.g. (mophologic characteristics, run velocity, length of flight on the springboard, duration of board contact, position of feet from springboard edge, duration of 1st flight phase, duration of support on table phase, duration of 2nd flight phase, height of jump, moment of inertia in x and y axis, distance from take-off 2nd flight phase, landing).

Čuk, Bricelj, Bučar, Turšič, & Atiković (2007) researched relations between start value (SV) of vault and runway velocity in top level male artistic gymnasts. They found correlation between runway velocity and SV with all gymnasts included competing at World Championship (WC) 1997 in Lausanne (N=204). Correlation coefficient was 0.51, which means that runway velocity and SV share 25% variance, which is very low (for

example – handspring salto forward tucked can be done with a large range of runway velocity). When vaults were grouped (e.g. average velocity for each vault - handspring salto tucked forward) and only average runway velocity per vault was considered, the correlation between vault runway velocity and SV was much higher with value of 0.70 and shared a variance of 49%, when vault SV from COP (FIG, 1997) were used and shared a variance of 53% when the COP (FIG, 2006) vault SV were used. . With the new philosophy of open ended COP, a new problem appeared: according to the COP (FIG, 2006), the apparatus are no longer equal.

Čuk & Atiković (2009), using a sample of 44 gymnasts who competed in all-around competition at the in Beijing 2008 Olympic Games (OG), found equality among apparatus scores. Equality was tested for using the achieved A scores of all MAG apparatus. Vault has the highest A scores, while pommel horse the lowest A scores. T-tests showed that those two apparatus significantly differed from other apparatus A scores by an average of 0.4 points. Factor analysis extracted 3 factors, with 67% of explained variance. On the 3rd factor, vault on positive side and pommel horse on the negative side were loaded. According to philosophy of the COP, the defined criteria

for calculation of vault difficulty values, biomechanical characteristics of the vaults are important in evaluating the DV.

Čuk & Forbes (2010) investigated the implications of the difficulty scores in relation to the success in all-around competition on a sample of 49 all-around male gymnasts at the 2009 European Championships. For all-around results, the D scores of the six apparatus are not equivalent with the COP (FIG, 2009): the vault and the pommel horse D scores significantly differed from other apparatus. With the COP (FIG, 2009), the vault D scores do not discriminate between all-around gymnasts and all-around gymnasts have the lowest D scores on pommel horse.

There are many studies reporting on vault run speeds – maximum speed on springboard, first and second flight phase (Sands & McNeal, 1995; Krug, 1997; Čuk & Karácsony, 2004; Takei, 2007; Čuk et al., 2007; Naundorf, Brehmer, Knoll, Bronst & Wagner, 2008; Ferkolj, 2010; Veličković, Petrović & Petrović, 2011). According to the philosophy of COP, the defined criteria for calculation of vault difficulty values, biomechanical characteristics of the vaults are important to evaluate the DV values. The aim of this paper is to find which biomechanical parameters explain and define the initial vault DV.

METHODS

The study sample included 64 vaults out of the possible 115 listed in the COP (FIG, 2009), from which we obtained data from the researches conducted to date. In collecting the data, we could not use all vaults because some of them, for example, second group vaults, have not been performed in the last 20 years. Analyzing all reading materials and video recordings from large world competitions, men perform some 30 different vaults, accounting for quarter of all vaults. A total of 64 different vaults have been collected with 12 variables. The sample of dependent variables includes difficulty values (COP) ranging from 2 to 7.2 points, while the

sample of independent variables include biomechanical variables shown in (Table 4).

The sample of independent variables are: degrees of turns in x and y axis in first and second flight phase (variable names: alpha in the x and y axis – the first and the second flight phase), shown on the basis of the COP (FIG, 2009) and defined by the quantity of rotations. The moment of inertia (J) was calculated by cylindrical model of Petrov & Gagin (1974) ($J=ml^2/12$) for the first and second flight phases and the moment of inertia in x and y axis (Table 5). Moment of inertia was calculated by above formula where (l) is the distance between lower and higher point of the body (for x axis) or distance between most left and right point of the body (for y axis). To calculate (l) we used morphologic data of vault specialists body height 1.6735 m and body mass 68.15 kg by Čuk & Karácsony (2004) within the Dempster body model (by Winter, 1979) and $g=9.81 \text{ m/s}^2$.

Duration parameters included: vault run speeds – maximum speed on springboard, first and second flight phase and duration of support on table phase determined as the average value from all vaults were calculated from elite gymnasts (N=230) performing at the 2006 WC in Aarhus, Denmark after analyzing video recordings from FIG (IRCOS-Instant Replay and Control System) as recorded at 50 frames per second (fps). BCG velocity on springboard, duration of the first and the second flight phases and duration of support on table phase are obtained from former studies (Sands & McNeal, 1995; Krug, 1997; Čuk & Karácsony, 2004; Takei, 2007; Čuk et al., 2007; Naundorf, Brehmer, Knoll, Bronst & Wagner, 2008; Ferkolj, 2010; Veličković, Petrović & Petrović, 2011).

Velocities of the dash are obtained from former researches, and body postures and moments of inertia in previously mentioned phases are taken as a model for all vaults. Average body positions and medium value, which were based on former studies, were taken in the phase of support on the table at group vaults. In terms of simplification of the model, only one value

for an individual group of vaults was taken because we know that a vault can be performed in different positions (e.g. handspring forward and salto forward), and can be performed either with the presented position in support on the table or with the higher position in the moment of support on the table. Duration "time" variables are also calculated based on previous studies and on the IRCOS WC 2009. It would be good to make a 3-D kinematic analysis for every vault, but for this type of research, we mention in the subject and in the problem, the individual jumps are difficult to collect because they havenot been performed for many years. Only ¼ of the total number of vaults from COP (FIG, 2009) are being performed at competitions. Due to the fact that we do not have all information about all the vaults, simplifications were needed in order to increase generalization, especially in the field of calculating position of the body for groups of vaults.

Data were processed as follows: in analyzing descriptive parameters of variables applied in vaults, Kolmogorov-Smirnov test to determine the normality of distribution of the results for further multivariate analysis, Pearson correlations, regression analysis with vault DV as criteria and selected biomechanical variables as predictors (according to the method entered). For the significance of the regression analysis, F test was used. As vaults are continuous actions where vault phases build on one another, we therefore selected only independent variables (a variable can not be a mathematical function of two or more known variable, as the variability of such variables do not bring any new variance). For that reason specifically, the analysis included the trajectory, the moment of inertia and individual vault phase times. We took into consideration correlations and multiple correlations at the significance level of $p < 0.05$.

RESULTS AND DISCUSSION

The deterministic model of attempted clarification of vault values with

biomechanical parameters in the men's artistic gymnastics was presented by descriptive parameters, significant correlations between 12 variables, and interpretation of results are presented into this section. The analysis and discussion begin with variables of 64 vaults, moments of inertia for various body positions in the first and second flight phases, Pearson correlation matrix, the regressive analysis of the criteria variable from the COP (FIG, 2009) and the impact of individual variables on the criteria variable.

In the correlations matrix (Table 6), criteria variables from the COP (FIG, 2009) effected a statistically significant correlation with five variables: BCG velocity on springboard ($r: 0.768, p < 0.05$), alpha in x axis 2nd flight phase ($r: 0.759, p < 0.05$), time of 2nd flight phase ($r: 0.646, p < 0.05$), time of 1st flight phase ($r: -0.486, p < 0.05$) and alpha in y axis 2nd flight phase ($r: 0.359, p < 0.01$). The reason for the relation between BCG velocity on the springboard and vault DV is that velocity on springboard proportionally increases from 6.0 m/s (Stoop) to 10.9 m/s (Dragulescu piked) as the vault's DV increases from 2.0 points (Stoop) to 7.2 points (Dragulescu piked). With higher velocity on the springboard (m/s), gymnasts increase the 2nd flight duration (s) and it allow them to perform a greater amount of rotation around the x body axis during the 2nd flight phase (range from 120 degrees (Stoop) to 900 degrees (Handspring forward and double somersault forward tucked) and consequently increase the vault's DV. The longer the duration of the flight time of the gymnast is during the 2nd flight phase ranging from 0.7 s (Handspring sideways with ¼ turn; DV: 3.0) to 1.2 s (Handspring sideways with ¼ turn the somersault forward piked; DV: 4.2), the vault's DV increases.

In Table 7, the predictor system of variables (R Square) explains 92% of the common variables with criteria, while the correlation of the entire predictor system of variables with criteria, the coefficient of multiple correlation amounts to 0.96 (RO).

Table 4. Values of selected variables of I, III, IV and V groups (N=64 vaults)

Ordinal number of jumps	Terminological description of the jump	Code of Points - FIG, 2009. (points)	BCG velocity on springboard (m/s)	Time of first flight phase (s)	Time of second flight phase (s)	Time of support on the table (s)	Alpha in x axis second flight phase (°)	Alpha in y axis second flight phase (°)	Alpha in x axis first flight phase (°)	Alpha in y axis first flight phase (°)	Moment of inertia J in x axis 1.f.p. (kgms ²)	Moment of inertia J in y axis 1.f.p. (kgms ²)	Moment of inertia J in x axis 2.f.p. (kgms ²)	Moment of inertia J in y axis 2.f.p. (kgms ²)
1.01	Stoop	2.0	6.00	0.30	0.75	0.12	120	0	120	0	1.706	0.000	0.738	0.000
1.02	Stoop with ½ t.	2.0	6.21	0.31	0.80	0.13	120	180	120	0	1.706	0.000	0.738	0.127
1.07	Hecht	2.2	6.80	0.32	0.84	0.14	120	0	120	0	1.706	0.000	1.731	0.000
1.08	Hecht with ½ t.	3.0	6.60	0.33	0.89	0.14	120	180	120	0	1.706	0.000	1.731	0.127
1.09	Hecht with 1/1 t.	4.2	7.00	0.32	0.86	0.14	120	360	120	0	1.706	0.000	1.731	0.127
1.10	Hecht with 3/2 t.	5.0	6.70	0.33	0.90	0.13	120	540	120	0	1.706	0.000	1.731	0.127
1.11	Hecht with 2/1 t.	5.4	7.33	0.32	0.84	0.15	120	720	120	0	1.706	0.000	1.731	0.127
3.01	Forward handspring	3.0	6.95	0.26	0.70	0.15	180	0	160	0	1.771	0.000	1.731	0.000
3.02	Forward handspring with ½ t.	3.4	7.10	0.27	0.71	0.21	180	180	160	0	1.771	0.000	1.731	0.127
3.03	Forward handspring with 1/1 t.	3.8	7.50	0.28	0.85	0.28	180	360	160	0	1.771	0.000	1.731	0.127
3.04	Forward handspring with 3/2 t.	4.2	7.60	0.29	0.74	0.24	180	540	160	0	1.771	0.000	1.731	0.127
3.05	Forward handspring with 2/1 t.	4.6	8.00	0.30	0.75	0.26	180	720	160	0	1.771	0.000	1.731	0.127
3.13	Handsprng fwd. and salto fwd. t.	3.8	7.20	0.24	0.92	0.16	540	0	160	0	1.771	0.000	0.458	0.000
3.14	Hdspr. fwd. and salto fwd. t. w. ½ t. (or Cuervo t.)	4.2	7.50	0.16	0.96	0.15	540	180	160	0	1.771	0.000	0.458	0.127
3.15	Hdspr. fwd. and salto fwd. t. w. 1/1 t. (Cuervo t. w. ½ t.)	4.6	8.20	0.17	0.97	0.12	540	360	160	0	1.771	0.000	0.458	0.127
3.16	Hdspr. fwd. and salto fwd. t. w. 3/2 t. (Cuervo t. w. 1/1 t.)	5.0	8.60	0.17	0.98	0.14	540	540	160	0	1.771	0.000	0.458	0.127
3.19	Handsprng fwd. and salto fwd. p.	4.2	7.50	0.28	0.90	0.16	540	0	160	0	1.771	0.000	0.458	0.127
3.20	Hdspr. fwd. and salto fwd. p. w. ½ t. (Cuervo p.)	4.6	8.03	0.22	0.91	0.16	540	180	160	0	1.771	0.000	0.738	0.127
3.21	Hdspr. fwd. and salto fwd. p. w. 1/1 t. (Cuervo p. w. ½ t.)	5.0	8.56	0.20	0.98	0.12	540	360	160	0	1.771	0.000	0.738	0.127
3.26	Hdspr. fwd. w. 1/1 t. and salto fwd. p. (Rehm)	5.8	7.70	0.08	1.00	0.12	540	360	160	0	1.771	0.000	0.738	0.127
3.31	Handsprng fwd. and salto fwd. str.	5.0	7.95	0.24	0.88	0.12	540	0	160	0	1.771	0.000	1.731	0.000
3.32	Hdspr. fwd. and salto fwd. str. w. ½ t. (Cuervo str.)	5.4	8.00	0.16	0.84	0.24	540	180	160	0	1.771	0.000	1.731	0.127
3.33	Hdspr. fwd. and salto fwd. str. w. 1/1 t. (Cuervostr. ½ t.)	5.8	8.05	0.17	0.91	0.19	540	360	160	0	1.771	0.000	1.731	0.127

3.34	Hdspr. fwd. and salto fwd. str. w. 3/2 t. (Cuervostr. w. 1/1 t.) (Lou Yun)	6.2	8.30	0.17	0.98	0.14	540	540	160	0	1.771	0.000	1.731	0.127
3.35	Hdspr. fwd. and salto fwd. str. w. 2/1 t. (Cuervostr. 3/2 t.)	6.6	8.60	0.16	0.96	0.16	540	720	160	0	1.771	0.000	1.731	0.127
3.36	Handspring fwd. and salto fwd. str. w. 5/2 t. (Yeo 2)	7.0	8.90	0.16	1.08	0.12	540	900	160	0	1.771	0.000	1.731	0.127
3.37	Handspring fwd. and dbl. salto fwd. t. (Roche)	6.6	8.23	0.18	1.09	0.11	900	0	160	0	1.771	0.000	0.458	0.000
3.38	Roche with 1/2 turn (Dragulescu)	7.0	10.50	0.16	1.12	0.12	900	180	160	0	1.771	0.000	0.458	0.127
3.39	Handspring fwd. and salto fwd. t. w. 1/2 t. and salto bwd. t. (Zimmerman)	7.0	10.50	0.20	1.12	0.12	900	180	160	0	1.771	0.000	0.458	0.127
3.40	Handspring fwd. and dbl. salto fwd. piked. (Blanik)	7.0	10.00	0.24	1.08	0.08	900	0	160	0	1.771	0.000	0.738	0.000
3.41	Dragulescu piked.	7.2	10.90	0.14	1.15	0.13	900	180	160	0	1.771	0.000	0.738	0.127
4.01	Handspring sw. with 1/4 t.	3.0	7.25	0.15	0.70	0.09	180	90	160	0	1.874	0.555	1.731	0.127
4.02	Handspring sw. with 3/4 t.	3.4	7.43	0.18	0.73	0.10	180	360	90	90	1.874	0.555	1.731	0.127
4.03	Handspring sw. with 5/4 t.	3.8	7.60	0.20	0.75	0.12	180	610	90	90	1.874	0.555	1.731	0.127
4.04	Hdspr. sw. with 1/4 t. a. salto fwd. t.	3.8	7.65	0.18	1.18	0.10	540	90	90	90	1.874	0.555	0.458	0.127
4.05	Handspring sw. w. 1/4 t. a. salto fwd. p.	4.2	7.90	0.20	1.02	0.11	540	90	90	90	1.874	0.555	0.738	0.127
4.07	Handspring sw. w. 1/4 t. a. salto fwd. str.	5.4	8.00	0.19	1.20	0.10	540	90	90	90	1.874	0.555	1.731	0.127
4.13	Handspring sw. w. 1/4 t. a. salto bwd. t. (Tsukahara)	3.8	7.00	0.16	0.98	0.18	540	90	90	90	1.874	0.555	0.458	0.127
4.14	Tsukahara t. with 1/2 t.	4.2	7.20	0.16	1.00	0.16	540	270	90	90	1.874	0.555	0.458	0.127
4.15	Hdspr. sw. w. 1/4 t. a. salto fwd. t. w. 1/2 t. (Kasamatsu)	4.6	7.20	0.14	0.88	0.22	540	450	90	90	1.874	0.555	0.458	0.127
4.17	Tsukahara t. with 2/1 t. (Barbieri)	5.4	7.60	0.12	1.04	0.22	540	810	90	90	1.874	0.555	0.458	0.127
4.19	Tsukahara piked	4.0	7.37	0.14	0.88	0.16	540	990	90	90	1.874	0.555	0.738	0.127
4.21	Tsukahara p. with 1/1 t.	4.8	7.51	0.12	0.96	0.20	540	450	90	90	1.874	0.555	0.738	0.127
4.25	Tsukahara stretched	4.6	7.65	0.14	0.85	0.26	540	90	90	90	1.874	0.555	1.731	0.127
4.26	Tsukahara str. with 1/2 t.	5.0	7.40	0.12	0.92	0.24	540	270	90	90	1.874	0.555	1.731	0.127
4.27	Tsukahara str. w. 1/1 t. or Kasamatsu str.	5.4	7.93	0.14	0.87	0.24	540	450	90	90	1.874	0.555	1.731	0.127
4.28	Kasamatsu str. with 1/2 t. or Tsukahara str. w. 3/2 t.	5.8	8.04	0.13	0.87	0.23	540	630	90	90	1.874	0.555	1.731	0.127
4.29	Kasamatsu str. w. 1/1 t. or Tsukahara str. w. 2/1 t. (Akopian)	6.2	8.13	0.14	0.96	0.21	540	810	90	90	1.874	0.555	1.731	0.127
4.30	Kasamatsu str. with 3/2 t. (Driggs)	6.6	8.50	0.14	0.98	0.19	540	990	90	90	1.874	0.555	1.731	0.127
4.31	Kasamatsu str. with 2/1 t. (Lopez)	7.0	8.87	0.16	1.00	0.16	540	1170	90	90	1.874	0.555	1.731	0.127
4.37	Tsukahara with salto bwd. t. (Yeo)	6.6	8.80	0.12	1.00	0.20	900	90	90	90	1.874	0.555	0.458	0.000
4.43	Tsukahara with salto bwd. piked. (Lu Yu Fu)	7.0	9.10	0.16	1.04	0.17	900	90	90	90	1.874	0.555	0.738	0.000
5.17	Yurchenko and salto bwd. t. (Melissanidis)	7.0	8.74	0.16	1.06	0.14	900	0	160	0	1.145	0.000	0.738	0.000

5.19	Yurchenko stretched	4.6	7.10	0.16	0.84	0.20	540	0	160	0	1.145	0.000	1.731	0.000
5.20	Yurchenko stretched with ½ t.	5.0	7.23	0.16	0.88	0.19	540	180	160	0	1.145	0.000	1.731	0.127
5.21	Yurchenko stretched with 1/1 t.	5.4	7.30	0.16	0.92	0.18	540	360	160	0	1.145	0.000	1.731	0.127
5.22	Yurchenko stretched with 3/2 t.	5.8	7.37	0.17	0.93	0.15	540	540	160	0	1.145	0.000	1.731	0.127
5.23	Yurchenko stretched with 2/1 t.	6.2	7.33	0.18	0.99	0.13	540	720	160	0	1.145	0.000	1.731	0.127
5.25	Yurchenko stretched with 5/2 t. (Shewfelt)	6.6	7.44	0.15	1.01	0.13	540	900	160	0	1.145	0.000	1.731	0.127
5.33	Round off, ½ t. and hdspr. fwd. with ½ t.	3.6	7.20	0.16	0.86	0.14	180	180	160	180	1.978	0.127	1.731	0.127
5.35	Round off, ½ t. and hdspr. fwd. with 1/1 t.	4.0	7.00	0.17	0.97	0.13	180	360	160	180	1.978	0.127	1.731	0.127
5.50	Round off, ½ t. and hdspr. fwd. a. salto fwd. str. w. ½ t. (Hutcheon)	5.6	7.53	0.16	0.88	0.12	540	180	160	180	1.978	0.127	1.731	0.127
5.55	Round off, ½ t. and hdspr. fwd. a. salto fwd. str. w. 5/2 t. (Li Xiao Peng)	7.2	8.23	0.20	0.96	0.08	540	900	160	180	1.978	0.127	1.731	0.127
5.79	Round off, jump bwd w. 1/1 t. to back hdspr. a. salto bwd. str. (Scherbo)	5.0	8.22	0.20	0.84	0.20	540	0	160	360	1.978	0.127	1.731	0.000

Table 5. Moments of inertia as calculated for various body positions in first and second flight phases.











Values calculated as per the model (J/g)	Body axis	Figure	Groups of vaults and body position in flight phase
1.706	x		I – Direct vaults
1.978	x		II – Vaults with full turns in first flight phase
1.771	x		III – Front handspring and (Yamashita style vaults)
1.874	x		IV – Vaults with 1/4 turn in first flight phase (Tsukahara & Kasamatsu)
1.145	x		V – Round-off entry vaults (Yurchenko, Nemov & Sherbo)
0.458	x		Tucked
0.738	x		Piked
1.731	x		Stretched
0.127	y		Shoulder width
0.555	y		Arch-like position in group IV vaults

Table 6. Correlation matrix.

Variable	COP, FIG, 2009. (points)	BCG velocity on springboard (m/s)	Time of first flight phase (s)	Time of second flight phase (s)	Time of support on the table (s)	Alpha in x axis second flight phase (°)	Alpha in y axis second flight phase (°)	Alpha in x axis first flight phase (°)	Alpha in y axis first flight phase (°)	Moment of inertia J in x axis 1.f.p. (kgms ²)	Moment of inertia J in y axis 1.f.p. (kgms ²)	Moment of inertia J in x axis 2.f.p. (kgms ²)	Moment of inertia J in y axis 2.f.p. (kgms ²)
Code of Points – FIG, 2009. (points)	1	.768*	-.486*	.646*	-0.052	.759*	.359**	0.135	0.026	-0.14	-0.02	-0.02	0.014
BCG velocity on springboard (m/s)		1	-.349*	.614*	-0.14	.748*	0.067	0.171	-0.028	0.132	-0.028	-.261*	-0.043
Time of first flight phase (s)			1	-.413*	-0.101	-.609*	-0.19	0.175	-.320*	-0.033	-.480*	0.167	-0.17
Time of second flight phase (s)				1	-.336*	.738*	0.036	-0.057	0.019	-0.023	0.084	-.461*	0.034
Time of support on the table (s)					1	-0.071	0.132	-0.207	0.092	0.021	0.202	0.208	0.103
Alpha in x axis second flight phase (°)						1	-0.116	0.046	0.035	-0.096	0.11	-.495*	-0.225
Alpha in y axis second flight phase (°)							1	-0.186	0.067	0.003	0.181	.304*	.524*
Alpha in x axis first flight phase (°)								1	-.366*	-.372*	-.870*	0.096	-0.119
Alpha in y axis first flight phase (°)									1	.502*	.528*	0.119	0
Moment of inertia J in x axis 1.f.p. (kgms ²)										1	.452*	-0.149	0.119
Moment of inertia J in y axis 1.f.p. (kgms ²)											1	-0.079	0.167
Moment of inertia J in x axis 2.f.p. (kgms ²)												1	0.156
Moment of inertia J in y axis 2.f.p. (kgms ²)													1

*. Correlation is significant at the 0.05 level (2-tailed).

Table 7. The regressive analysis of the criteria variable COP (FIG, 2009),

Model	R	R Square	Adjusted R Square	Std. Error of the Estimate	R Square Change	Change Statistics			Sig. F Change
						F Change	df1	df2	
1	.961 ^a	.924	.906	.418	.924	51.768	12	51	.000

Table 8. *The impact of individual variables on the criteria variable COP (FIG, 2009).*

Model	Unstandardized Coefficients		Standardized Coefficients	t	Sig.	95,0% Confidence Interval for B	
	B	Std. Error	Beta			Lower Bound	Upper Bound
1 (Constant)	-2.063	1.410		-1.463	.150	-4.894	.768
Code of Points – FIG, 2009. (points)	.219	.120	.151	1.832	.073	-.021	.459
BCG velocity on springboard (m/s)	.941	1.731	.043	.543	.589	-2.535	4.416
Time of first flight phase (s)	1.418	.886	.121	1.599	.116	-.362	3.197
Time of second flight phase (s)	-.679	1.355	-.024	-.501	.619	-3.400	2.042
Time of support on the table (s)	.005	.001	.835	6.638	.000	.003	.006
Alpha in x axis second flight phase (°)	.002	.000	.375	7.308	.000	.001	.002
Alpha in y axis second flight phase (°)	-.003	.005	-.066	-.583	.562	-.012	.007
Alpha in x axis first flight phase (°)	.000	.001	.007	.128	.899	-.002	.002
Alpha in y axis first flight phase (°)	.300	.381	.049	.787	.435	-.465	1.065
Moment of inertia J in x axis 1.f.p. (kgms ²)	-1.116	.689	-.211	-1.621	.111	-2.498	.266
Moment of inertia J in y axis 1.f.p. (kgms ²)	.888	.137	.373	6.489	.000	.613	1.163
Moment of inertia J in x axis 2.f.p. (kgms ²)	-.544	1.481	-.020	-.367	.715	-3.517	2.430

The analysis of the impact of individual variables in Table 8 showed that the highest and statistically most important influence of the criteria variables from the COP are with the following individual variables: alpha x in the 2nd flight phase (Beta: 0.835, sig.<0.001), alpha y in the 2nd flight phase (Beta: 0.375, sig.<0.001) and the moment of inertia J_x in the 2nd flight phase (Beta: 0.373; sig.<0.001). Prediction was significantly correlated with only three variables, meaning that the present vault difficulties COP (FIG, 2009) are defined by these three variables of the 2nd flight phase. The regressive analysis clearly shows that the initial value prediction is very high. Degrees of turns around transversal and longitudinal axis, and body position in the

2nd flight phase are the only predictors and the most significant predictors in the COP

(FIG, 2009). It can be noted that the FIG Technical Committee only considered the 2nd flight phase starting with the table take-off onwards to just before landing. Hence, the 5 different vaults to support on the apparatus have no significant prediction to initial jump difficulty level. While Pearson correlation between DV value and BCG velocity on the springboard is the highest in regression analysis (r: 0.768, p<0.05), the variance of the velocity is related to other parameters, probably mostly to alpha x in 2nd flight phase (r: 0.759, p<0.05).

Bruggemann (1987) and Kwon (1996) noted that the DV is often increased by adding more rotations of somersaults into its

basic form. Bruggemann (1987) reviewed the research literature on gymnastics vaulting, based largely on his work on continuous rotation vaults. He reported that the higher skilled gymnasts were better able to increase the linear and angular moment at horse take-off than the lower skilled gymnasts. He concluded that approach velocity was of high significance to the overall performance of vault. It would appear that the success of a vault could be attributed to a large extent to the 1st flight phase characteristics. However, Bruggemann (1994) noted that the purpose of 2nd flight phase is to alter the 1st flight phase. This is established by generating lift through a higher vertical velocity and maintaining sufficient momentum for the postflight since the main goal of the vault is to establish height and distance in the second flight phase, which contains the actual difficulties of the vault.

Takei, Blucker, Nohara & Yamashita (2000) used correlation analysis to establish the strength of the relationship between the causal mechanical variables identified in the model and the judges' scores. From the 18 significant variables identified in the present study, the angular distance of 1st and 2nd flight phases, the horizontal velocity and angular momentum at take-off from the horse, and the average moment of inertia and duration of 2nd flight phase collectively accounted for 57% of the variation in the judges' scores. Continuation of the vault and the results are meaningful when viewed together with the continued movement of the vault in performance as a second flight phase follows. This can be explained if the biomechanical aspects of the more demanding first flight phase of the jump in terms of modes of movement (direction, rotation, body's positions, the phases of flight). The gymnast must be, for a very short period of time, prepared for the continuation of the vault. Takei (2007) in his handspring double salto forward tucked study analyzed the strength of the relationship between the mechanical variables identified and the judges' scores. Significant correlations indicated that the

higher judges' scores were negatively related to five mechanical variables and positively related to seventeen variables in the model. The normalized horizontal displacement of body center of mass (BCM) from the knee grasp to the peak of 2nd flight phase was the best single predictor of the judges' score and accounted for 50% of variation in the judges' score. The landing point deductions and the official horizontal distance of 2nd flight phase collectively accounted for 86% of the variance in the judges' scores.

The regression analysis results lead us to the conclusion that members of the FIG men's technical committee had in mind a simple model of the COP, which would easily determine the vault difficulty level. The present vault DV model of the COP (FIG, 2009) is not too complicated, however it obviously does not differentiate difficulty among vault groups and their most important biomechanical components.

CONCLUSIONS

Bearing in mind the results, one could make a better model of determining the DV of a vault. In future analysis, it would first be necessary to establish latent dimensions that can define the vaults and followed by a factor analysis of whether the vaults are explained only with three variables from the manifest variable space (degrees of turns around transversal axis, degrees of turns around longitudinal axis and body's and moment of inertia around transversal axis in second flight phase). From the factor analysis, we could determine independent factors that define the vaults and, with the results of the factor analysis, it would be possible to propose better evaluation of the vault difficulty.

REFERENCES

- Arkaev, L., Suchilin, N. (2003). *How to Create Champions*. Meyer & Meyer Fachverlag und Buchhandel GmbH.
- Atiković, A. (2011). *Modeliranje početnih vrijednosti preskoka po pravilima*

FIG u muškoj sportskoj gimnastici sa vidika biomehaničkih značajnosti skokova

[Modeling start value of vaults per FIG Code of Points in men's artistic gymnastics with the biomechanical aspects of the significance vaults]. (Unpublished doctoral dissertation, University of Sarajevo). Sarajevo: Faculty of Sport and PE.

Brüeggmann, G.P. (1987).

Biomechanics in gymnastics. In B. Van Gheluwe & J. Atha (Eds.), *Current Research in Sport Biomechanics. Medicine and Sport Science*, 25, 142-176. Basel: Karger.

Brüeggmann, G.P. (1994).

Biomechanics of gymnastic techniques. In R. Nelson & V. Zatsiorsky (Eds.), *Sport Science Review*, 3, 79-120. Champaign, IL: Human Kinetics

Čuk I., Atiković, A. (2009). Are Disciplines in All Around Men's Artistic Gymnastics Equal. *Sport scientific and practical aspects*, 6(1-2), 7-12. Tuzla: University, Faculty of PE and Sport, University of Tuzla.

Čuk I., Forbes, W. (2010). How apparatus difficulty scores affect all around results in men's artistic gymnastics. *Science of Gymnastics Journal*, 2(3), 57-63.

Čuk, I., Bricelj, A., Bučar, M., Turšič, B. and Atiković, A. (2007). Relations between start value of vault and runway velocity in top level male artistic gymnastics. In N.Smajlović (Eds.), *Proceedings Book of 2nd International Scientific Symposium, Sarajevo, 2007, "NTS New Technologies in Sport"* (pp. 64-67). Sarajevo: Faculty of Sport and PE, University of Sarajevo.

Čuk, I., I. Karacsony (2004). *Vault : methods, ideas, curiosities, history*. Ljubljana: ŠTD Sangvinčki.

Ferkolj, M. (2010). A kinematic analysis of the handspring double salto forward tucked on a new style of vaulting table. *Science of Gymnastics Journal* 2(1), 35-48

FIG Code of Points (1964). *Pravilnik za suđenje i ocjenjivanje, Muška sportska gimnastika*, Gimnastički savez Jugoslavije, Beograd.

FIG Code of Points (1971). *Pravilnik za ocenjevanje vaj na orodju v moški športni gimnastiki, I. Razreda članov in mladincev*, Gimnastična zveza Slovenije, Ljubljana.

FIG Code of Points (1978). *Pravila za ocenjivanje, Muška sportska gimnastika*, Gimnastički savez Jugoslavije, Beograd.

FIG Code of Points (1985). *Pravilnik za ocenjivanje vaj na orodju v moški športni gimnastiki*, Gimnastična zveza Slovenije, Ljubljana.

FIG Code of Points (1989). *Pravila za ocenjivanje, Muška sportska gimnastika*, Gimnastički savez Srbije, Beograd.

FIG Code of Points (1993). *Pravilnik za ocenjivanje vaj na orodju v moški športni gimnastiki*, Gimnastična zveza Slovenije, Ljubljana.

FIG Code of Points (1997). *Pravilnik za ocenjivanje vaj na orodju v moški športni gimnastiki*, Gimnastična zveza Slovenije, Ljubljana.

FIG Code of Points (2001). *Bodovni pravilnik, Muški tehnički odbor, Hrvatski gimnastički savez*, Zagreb.

FIG Code of Points (2006). *Code of Points for Men*. Federation internationale de gymnastique, Moutier.

FIG Code of Points (2009). *Code of Points for Men*. Federation internationale de gymnastique, Moutier.

Gavrdovsky, J.K., Smolevsky, V.M. (1979). *Sportivnaja gimnastika*. FIS, Moskva.

Gervais, P. (1994). A prediction of an optimal performance of the handspring 1 ½ front salto longhorse valut. *Journal of Biomechanics*, 27(1): 67-75.

Krug, J. (1997). *Scientific Project Gymnastics World Championship 1997 Lausanne*. Lousanne: FIG et. Institute for Applied Training Science Lepizig.

Krug, J., Knoll, K., Koethe, T., & Zoecher, H.D. (1998). Running approach velocity and energy transformation in difficult vaults in gymnastics. In, Hartmut J. Riehle & Manfred M. Vieten, (Eds.) *Proceedings of XVI International Symposium on Biomechanics in Sports*, (pp.

160-163), UVK Universitätsverlag
Konstanz, Germany.

Liang, C., Tian, M. (2003). On gymnastics frontier technical creations. *Proceedings of 2003 Science in Gymnastics Symposium USA Gymnastics National Congress*, Anaheim, CA.

Marinšek, M. (2010). Basic landing characteristics and their implication. *Science of Gymnastics Journal*, 2(2), 59-67.

Naundorf, F., Brehmer, S., Knoll, K., Bronst, A., Wagner, R. (2008). Development of the velocity for vault runs in artistic gymnastics from the last decade. *Proceedings of 26th International Conference on Biomechanics in Sports* (pp. 481-484). Retrived Decembar 22, 2010 from: <http://w4.ub.uni-konstanz.de/cpa/article/viewFile/1905/1774>

Petrov, V., Gagin, J. (1974). *Mehanika sportskih dvizenji*. Moskva: Fiskultura i sport.

Prassas, S. (1995). Biomechanics in gymnastics: an overview. *Proceedings of '95 KNUPE, International Symposium*, (pp. 84-93), The Research Institute of Physical Education and Sports Science, Korean National.

Prassas, S. (2002). *Valuting mechanics*. Retrived September 12, 2007 from: <http://coachesinfo.com/category/gymnastics/315/>

Sands, W.A., McNeal, J.R. (1995). The relationship of vault run speeds an flight duration to score. *Technique*, 15(5), 8-10.

Schwiezer, L. (2003). *Valuts with new table*. Federation internationale de gymnastique, Moutier.

SPSS 12.0 for Windows (2003). *Statistical package for the social sciences*. SPSS, Inc., Chicago, IL, USA

Such., J. (2007) *Sport specific biomechanics*. Retrived November 06, 2010 from: <http://www.portsmouth-gymnastics.com/L4%20TG%20Sport%20pecific%201.pdf>

Takei, Y. (1991). A comparision of techniques used in preforming the men s compulsory gymnastics valut at 1988

Olympics. *International Journal of Sports Biomechanics*, 7(1), 54-75.

Takei, Y., (1998). Three-dimensional analysis of handspring with full turn vault: deterministic model, coaches beliefs, and judges Scores. *Journal of Applied Biomechanics*, 14(2), 190-210.

Takei, Y., (2007). The roche vault performed by elite gymnasts: somersaulting technique, deterministic model, and judges' scores. *Journal of Applied Biomechanics*, 23(1), 1-11.

Takei, Y., Blucker, EP., Nohara, H., Yamashita, N. (2000). The Hecht vault performed at the 1995 World Gymnastics Championships: deterministic model and judges' scores. *Journal Sports Sciences*, 18(11): 849-63.

Ukran, M.L., Šlemin, A.M. (1977). *Gimnastika*. Moskva: Fiskultura i Sport.

Veličković, S., Petković, D., Petković, E. (2011). A case study about differences in characteristics of the run-up approach on the vault between top-class and middle-class gymnasts. *Science of Gymnastics Journal* 3(1), 25-34.

Winter D.A. (1979). *Biomechanics of human movement*. J. Wiley & sons, New York.

Corresponding author

Almir Atiković
Faculty of Physical Education and Sport
Universty of Tuzla
2. Oktobra 1,
75 000, Tuzla,
Bosnia and Hercegovina;
e-mail: almir.atikovic@untz.ba

Slovenski izvlečki / Slovene Abstracts

Thomas Heinen, Damian Jeraj, Pia M. Vinken, Katharina Knieps, Konstantinos Velentzas & Hedi Richter

KAJ JE POTREBNO ZA IZVEDBO DVOJNEGA JAEGER SALTA NA DROGU?

Jaeger salto (z zakolebom spust salto naprej na drogu v zakoleb) je osnovni spust na drogu, katerega se telovadci učijo že zgodaj. Telovadci so naredili velik napredek v tehniki gibanj na drogu, cilj raziskave pa je bil ugotoviti ali je dvojni Jaeger salto možno izvesti in pod kakšnimi pogoji. Narejena je bila računalniška simulacija dvojnega skrčenega in sklonjenega Jaeger salta. Osnovni model je bil narejen na osnovi resničnih podatkov izvedbe različnih Jaeger in Gaylord saltov. Pomembne spremenljivke modela so bile navpična in vodoravna hitrost težišča telesa telovadca ob zapuščanju droga, vztrajnostni moment telovadca in koti med deli telesa. Izračunanih je bilo 940896 različnih simulacij izvedbe, od tega jih je bilo 3.26% uspešnih za dvojni skrčeni Jaeger salto in 2.50% za sklonjeno izvedbo. Dvojni Jaeger salto je možno izvesti, telovadec pa mora zagotoviti primerno vrtilno količino in trajanje leta.

Ključne besede: simulacija, kontrola gibanja, tehnika, gimnastika.

Stefan Brehmer & Falk Naundorf

RAZVOJ HITROSTI ZALETA NA PRESKOKU S STAROSTJO TELOVADCEV

Zalet na preskoku je v literaturi navajan kot najpomembnejši dejavnik izvora energije za uspešno izveden preskok. Hitrost zaleta naj bi se glede na biološke značilnosti človeka rahlo razvijala do prehoda telovadca v člansko kategorijo, za kar so odgovorni različni mehanizmi. Za povečanje hitrosti od otroštva v mladostništvo so predvsem odgovorni mehanizmi kontrole gibanja. Na začetku pubertete je za povečanje hitrosti pri moških osnovni vzrok spremenjeno delovanje hormonov. Za dokaz omenjenih trditev smo primerjali hitrost zaleta v različnih obdobjih gibalnega razvoja; štiri leta smo spremljali telovadce različnih starostnih kategorij na različnih tekmovanjih v gimnastiki. Zaletna hitrost se povečuje do konca mladinske kategorije, v članski kategoriji pa ostaja nespremenjena. Sprememba hitrosti v puberteti in mladostništvu se ne razlikujeta. Mehanizmi kontrole gibanja in razvoja mišične sile enakovredno določajo zaletno hitrost.

Ključne besede: starost, razvoj, zaletna hitrost, preskok, moška športna gimnastika.

Ivan Čuk, Samo Penič, Dejan Križaj

NASPROTI PAMETNI ODRIVNI DESKI (ŠTUDIJA PRIMERA)

Različne merske naprave se uporabljajo na preskoku v gimnastiki, vendar nobena ni posebej razvita za odzivno desko. Po analizi literature smo se odločili razviti mersko napravo za merjenje delovanja odzivne deske. Nova naprava je sestavljena iz računalnika z LCD ekranom, ki je povezan s pospeškomerom, ki je nameščen pod odzivnim mestom. Pospeškomer meri v dveh smereh s hitrostjo 1000 Hz. Iz dobljenih pospeškov je izračunana in prikazana hitrost odziva in trajanje odziva. Podatke se lahko prenaša v namizni računalnik preko USB vmesnika. S pomočjo programa MATLAB lahko podatke shranimo, prečistimo in analiziramo. Dobljeni rezultati so podobni tistim, ki so dobljeni na potiskovni plošči in laserskim merilcem razdalje (podobne hitrosti in časi trajanja). Z novo napravo je možno določiti značilne aktivnosti odzivne deske posameznega telovadca, optimalne vrednosti za posamezno vrsto skoka, sposobnost natančnega ponavljanja odziva telovadca, ugotavljati simetričnost odziva, in optimizirati uspešnost treninga. Naprava se lahko uporabi na treningu za hitro pridobivanje in analiziranje podatkov, kakor tudi za raziskovalne namene.

Ključne besede: merilne naprave, pospeškomer, odzivna hitrost, preskok

William A. Sands, Jeni R. McNeal, Monèm Jemni & Gabriella Penitente

RAZMIŠLJAJMO PREUDARNO O PREVENTIVI PRED POŠKODBAMI IN VARNOSTJO

Kljub pozornosti medijev, pedagogov in zdravnikov ostajajo poškodbe najbolj pereč problem gimnastike. Programi preventive, regeneracije in zdravljenja so bili predlagani velikokrat, največkrat naključno izvajani in malokrat zaslužni za zmanjšanje pojavnosti poškodb. Pri preprečevanju poškodb moramo razmišljati o veliko stvareh od varnosti orodij do odnosa trenerjev do športnikov. Na žalost, če je eden izmed protiukrepov neustrezen je poškodba verjetna. Izdelan je bil model za preprečevanje poškodb in varnost na osnovi dosedanje literature, in predvideva pet sklopov. Vsak sklop je obravnavan in predlagani so ukrepi za preprčitev poškodb.

Ključne besede: gimnastika, trening, nevarnost.

Luísa Amaral, Albrecht Claessens, José Ferreirinha & Paulo Santos

PREGLED SPREMENLJIVOSTI PODLAHTNICE IN Z NJO POVEZANI DEJAVNIKI PRI TELOVADCIH

Spremenljivost podlahtnice je povezana z relativno dolžino koželjnice. Morfološke razlike v distalnih epifiznih strukturah lahko povzroči simptome ali patološke spremembe na zapestju. Da bi lahko ocenili in izmerili neskladje podlahti (podlahtnice in koželjnice) se uporabljajo različne tehnike merjenja (slikanja), odvisno od razvitosti posameznika. Namen članka je povzeti trenutno literature in opis trendov raziskovanja spremenljivosti podlahtnice ob upoštevanju bioloških značilnosti in obremenitve posameznika. Opremljena je pogostost pozitivnih, nevtralnih in negativnih spremenljivosti podlahtnice med telovadci in splošno populacijo. Ob tem so opredeljeni dejavniki tveganja poškodbe zapestja, ki ponavadi najbolj vpliva na zdravje in uspešnost telovadcev.

Ključne besede: gimnastika, morfologija, zapestje, poškodbo.

Almir Atiković, Nusret Smajlović

RAZMERJE MED TEŽAVNOSTJO IN BIOMEHANIČNIMI ZNAČILNOSTMI PRESKOKOV V MOŠKI ŠPORTNI GIMNASTIKI

Namen raziskave je bil ugotoviti, katere biomehanične značilnosti pojasnjujejo in določajo vrednosti težavnosti preskoka. V vzorec je bilo vključenih 64 preskokov iz Pravil FIG za ocenjevanje v moški športni gimnastiki. Odvisna spremenljivka je bila vrednost težavnosti preskokov v razponu od 2,0-7,2 točke, vzorec neodvisnih spremenljivk je predstavljalo 12 biomehaničnih spremenljivke (podatki so bili zbrani iz literature in lastnih meritev). Z regresijsko analizo smo pojasnili 92,4% vrednosti težavnosti. Le tri spremenljivke drugega leta značilno napovedujejo težavnost preskoka in sicer: količina vrtenja okoli čelne osi, količina vrtenje okoli dolžinske osi stopinj in vztrajnostni moment telesa.

Ključne besede: Pravila FIG, Gimnastika, težavnost, biomehanika.

Dear friends,

In the past many of you asked for the following books. As the time goes by, we decided to transform books in the *.pdf format.

For more info e-mail: ivan.cuk@fsp.uni-lj.si

